

DAITARN 3 MACH PATROL

GARAGE BUILD - Sc. 1:18

"Daitarn 3"(無敵網人ダイターン3) copyright by Sunrise ©1978

Templates and instructions by COSEDIMARCO®

Rev. 1.0.0

www.COSEDIMARCO.com

info@cosedimarco.com



MATERIALS:

- Plywood th. 2 mm.
- Plywood th. 3 mm.
- Wood veneer th. 1 mm.
- PVC Tube th. 7 mm.
- PVC th. 1 mm.
- Solid wood

Use this Ruler as
reference for printing



OVERALL DIMENSIONS:

CAR MODE

Length: 309 mm.

Width: 146 mm.

Height: 86 mm.

FLYING MODE

Length: 391 mm.

Width: 395 mm.

Height: 95 mm.

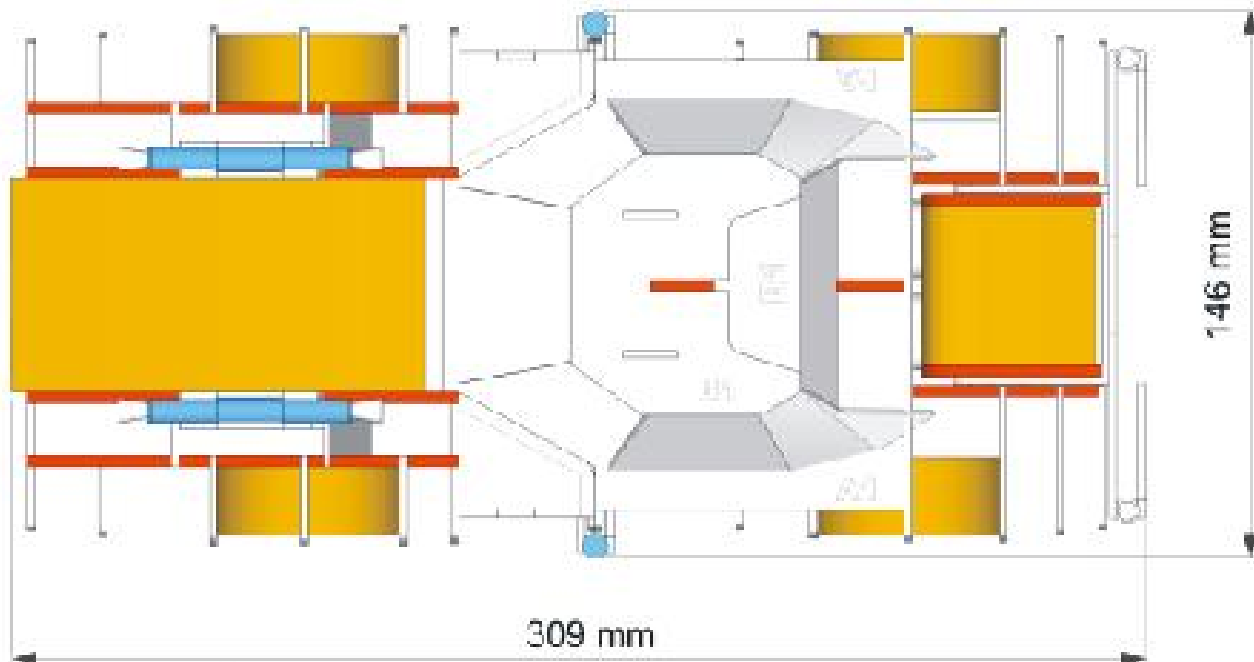
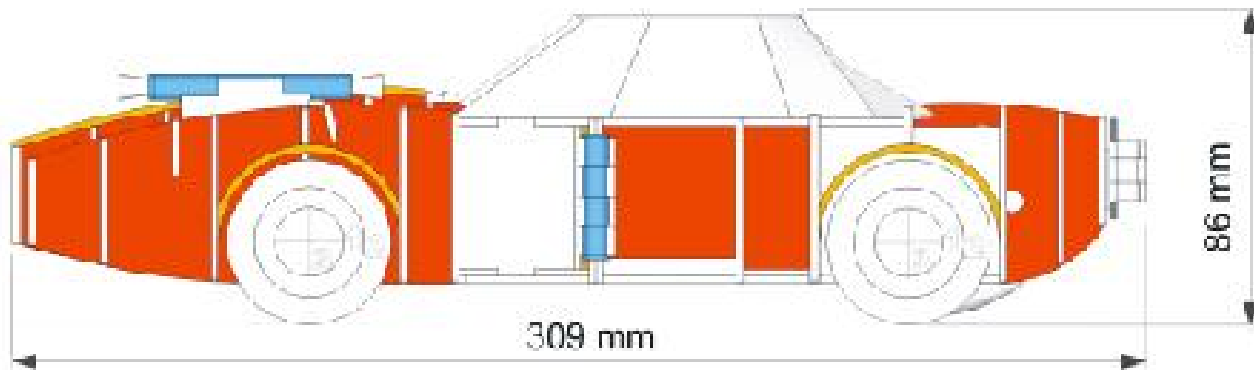
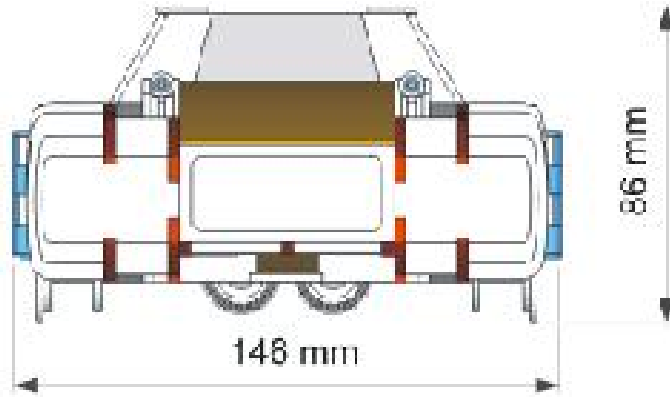

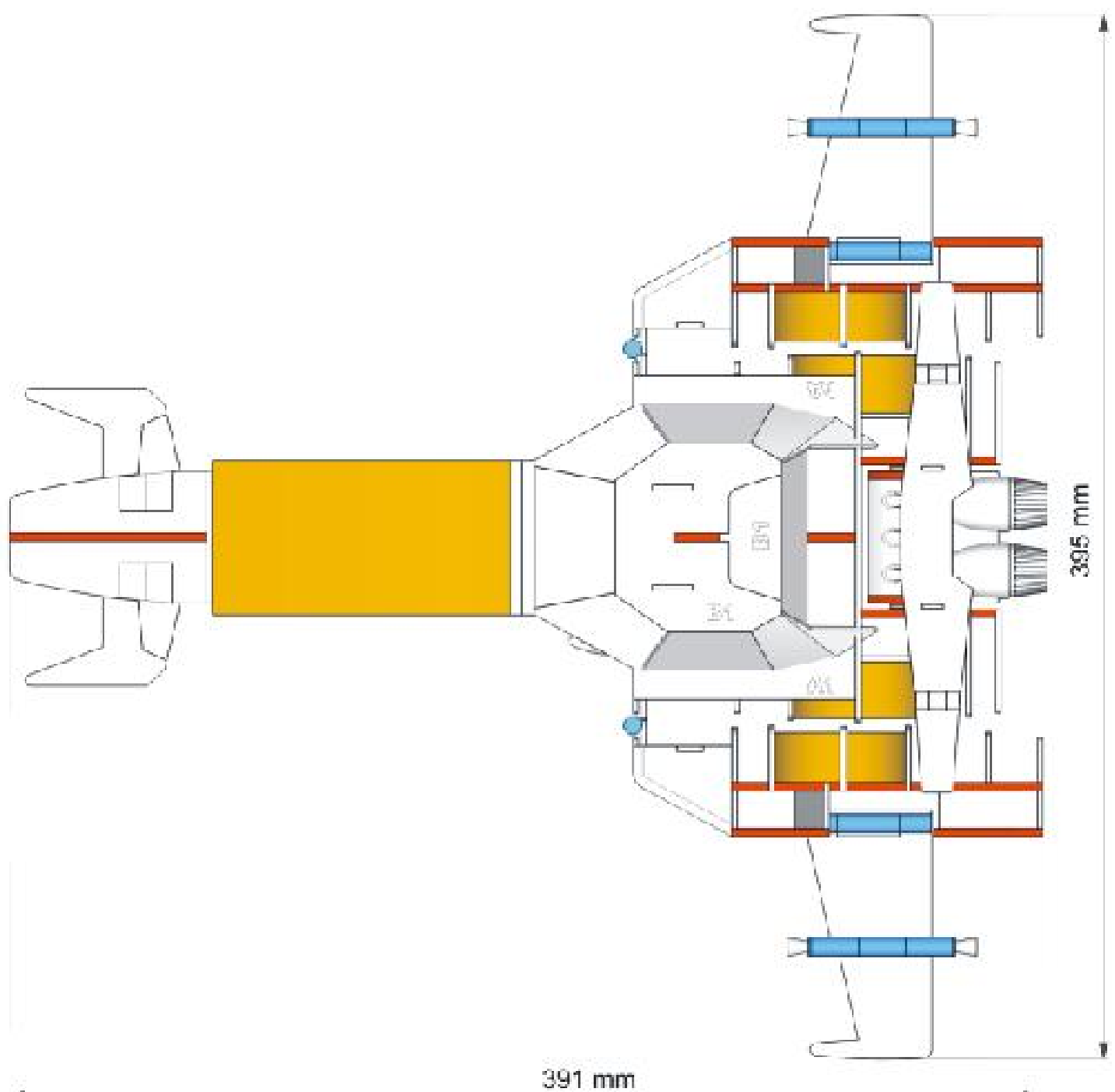
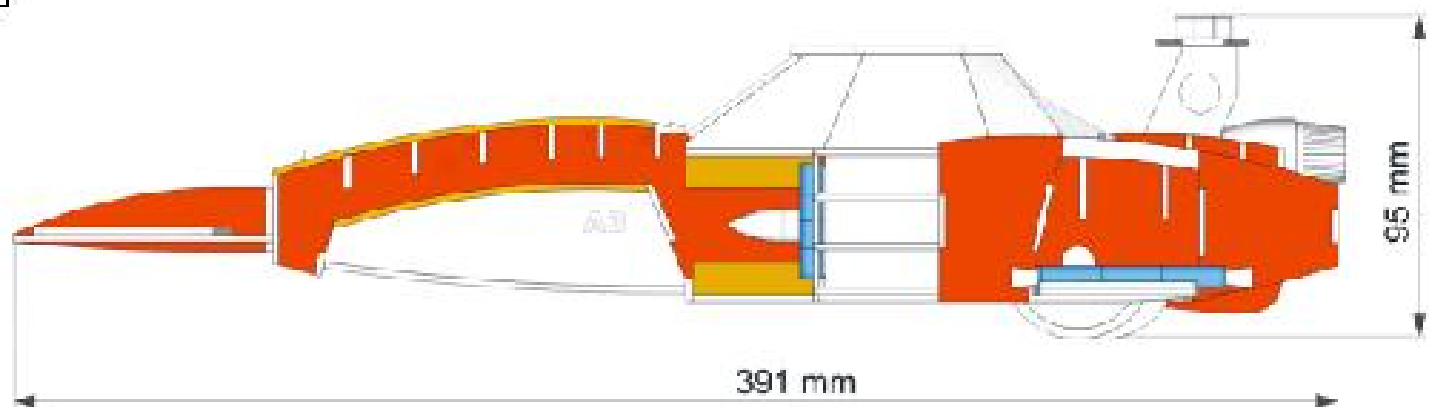
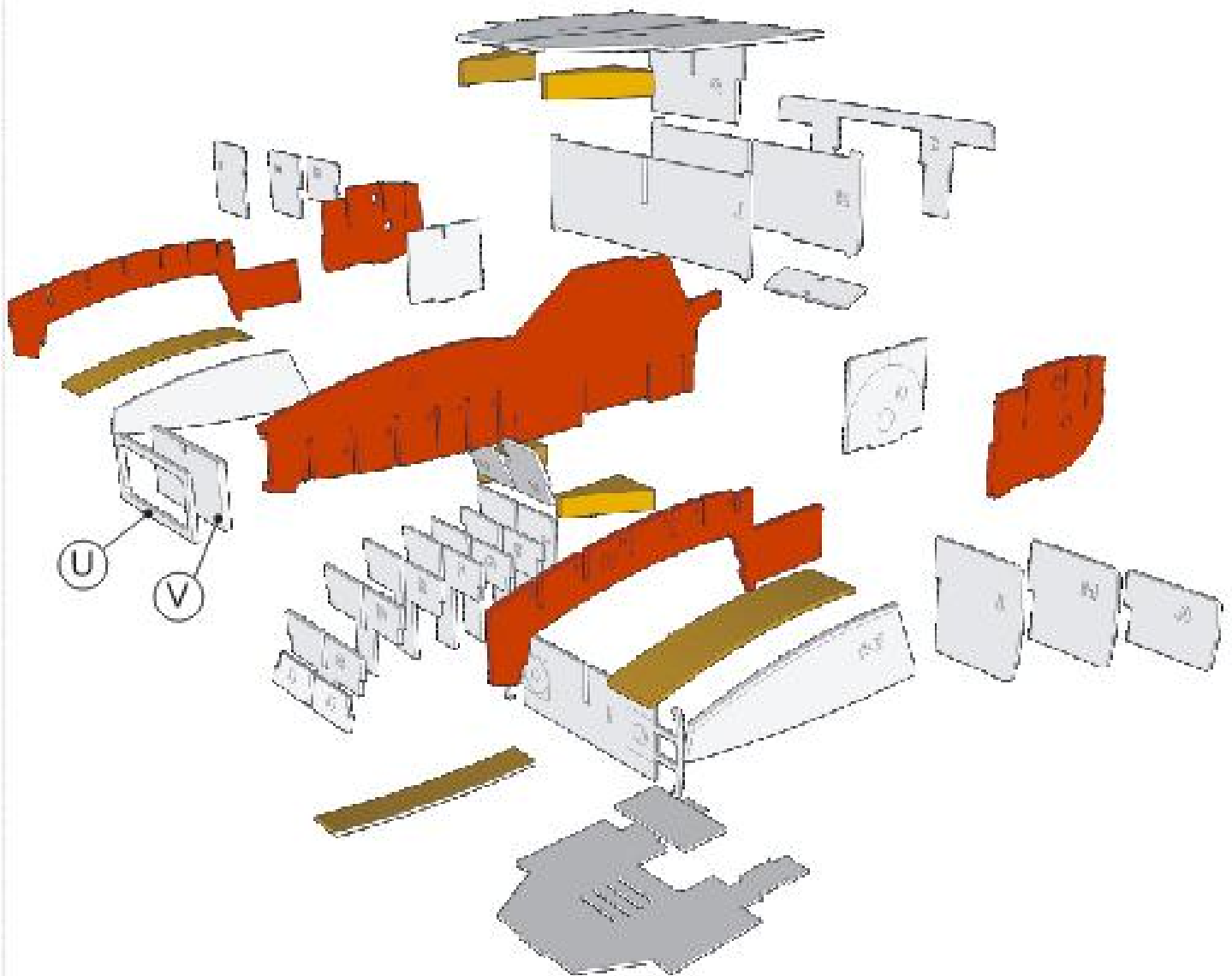
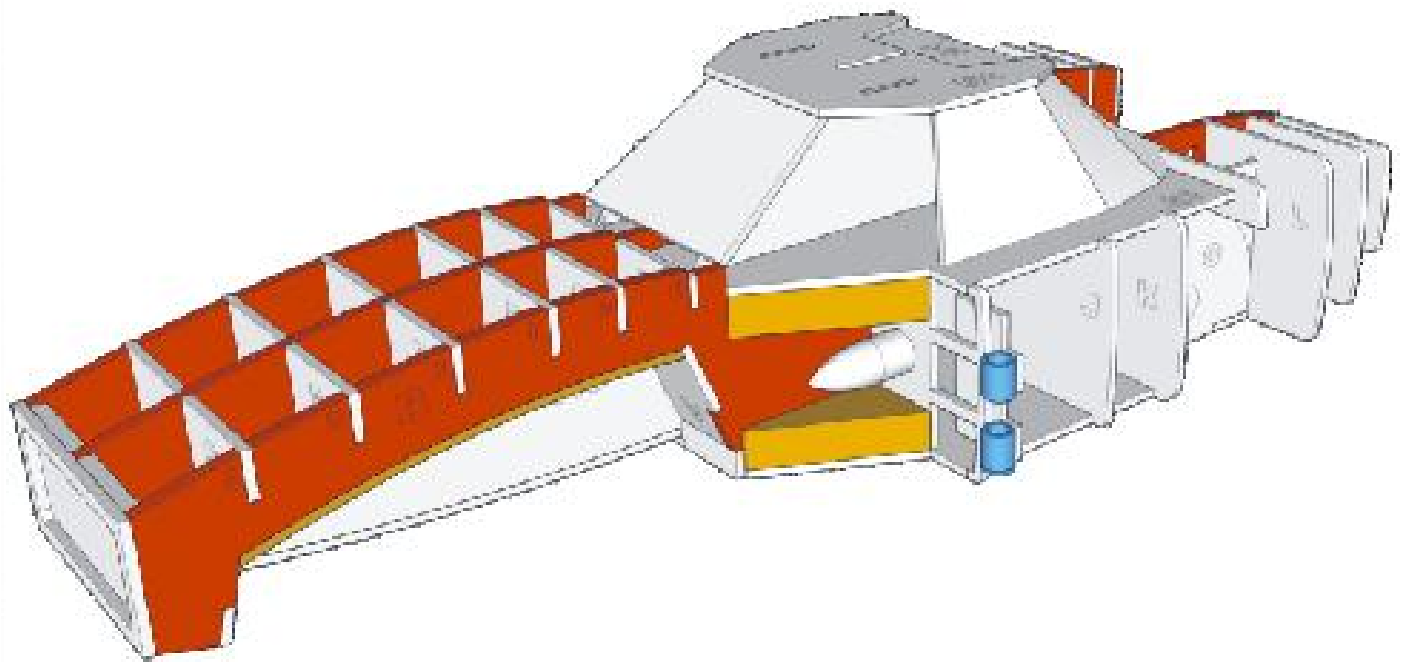
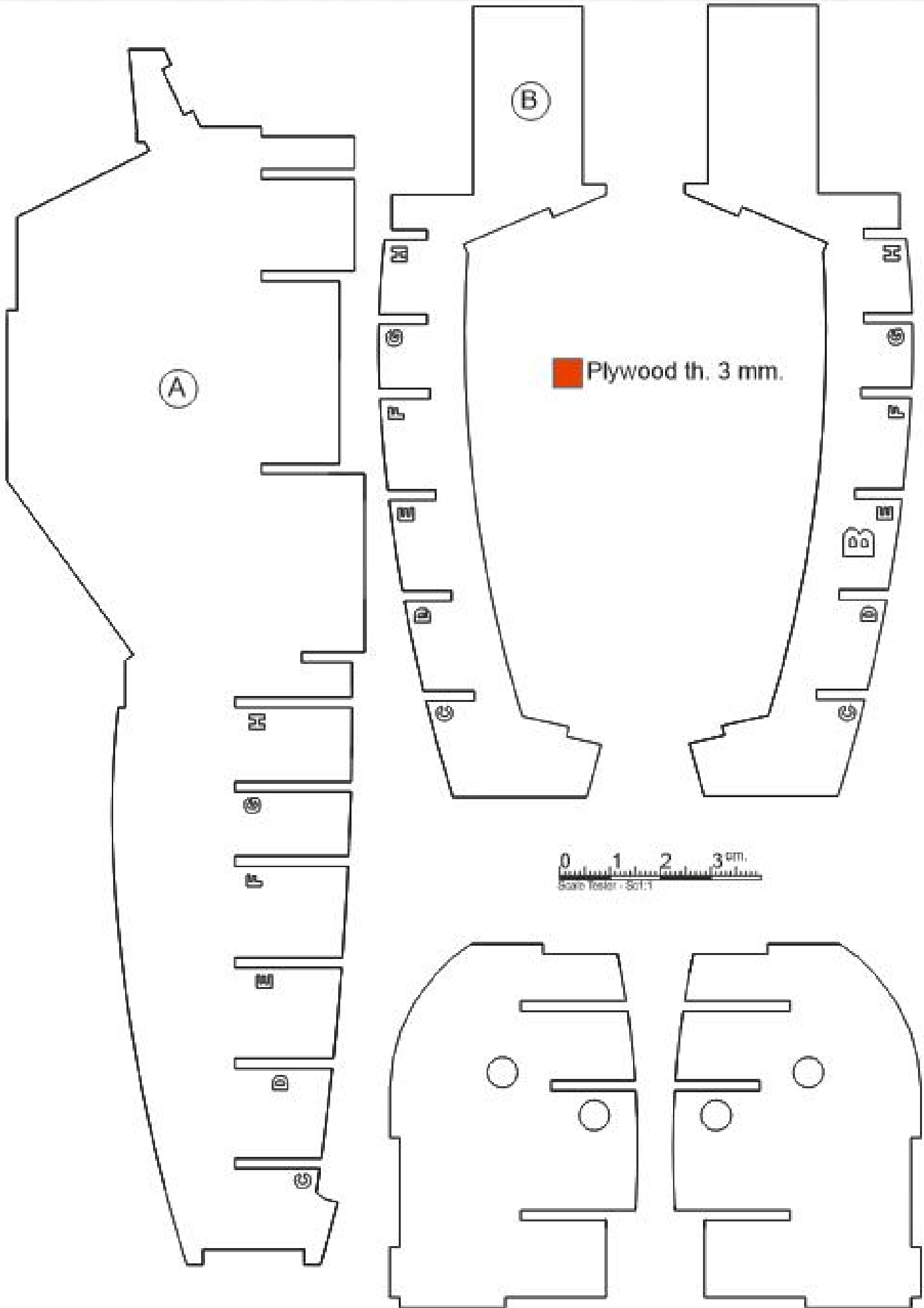
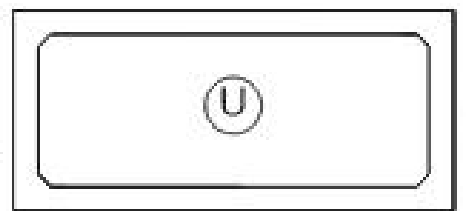
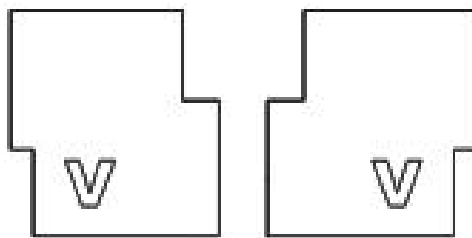
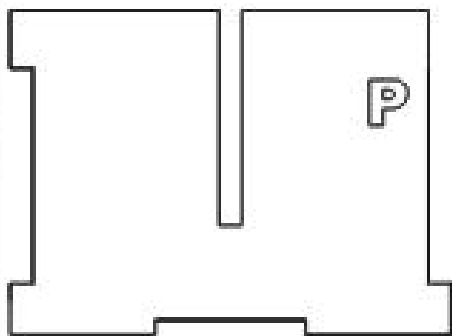
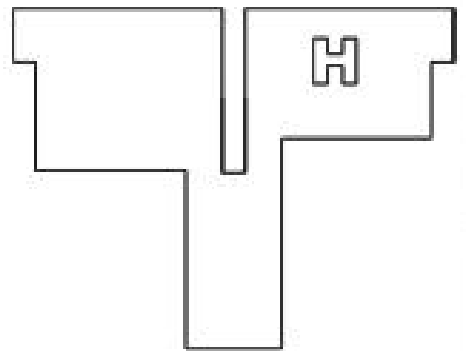
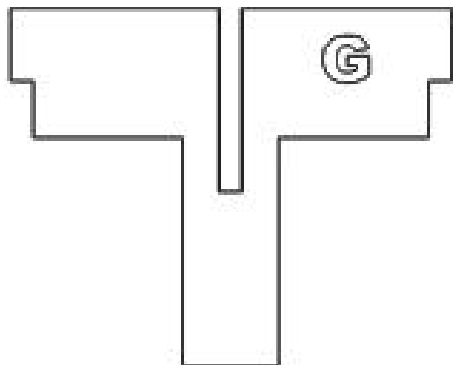
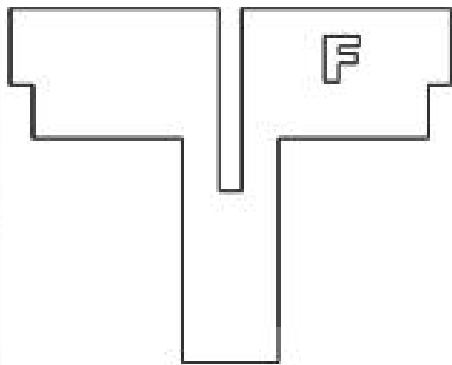
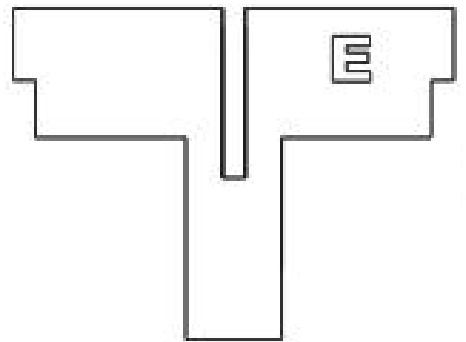
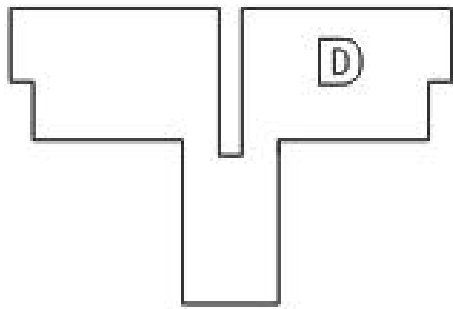
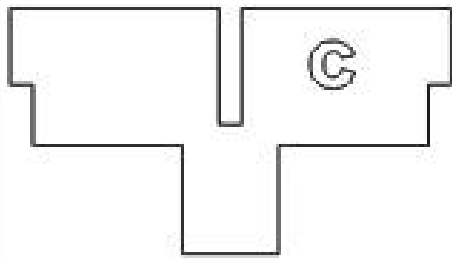



ILLUSTRATION QUALITY PAPER FOR FULL BLEED AND REGULAR COMIC BOOK PAGES. FINISHED ART PRINTS AT 67%







 Plywood th. 2 mm.

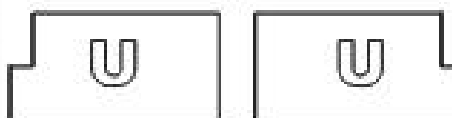
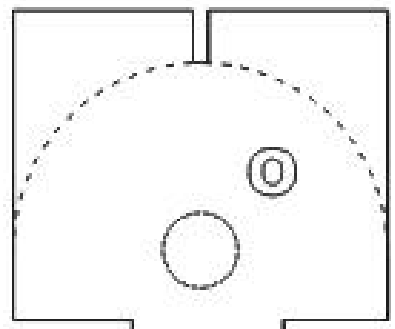
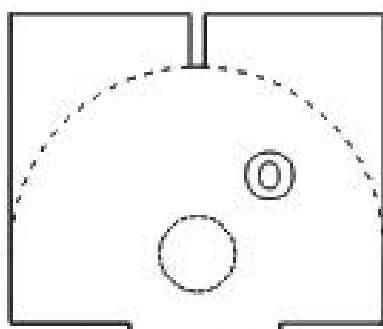
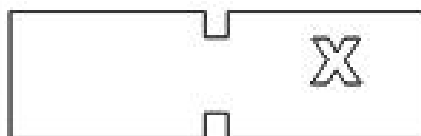
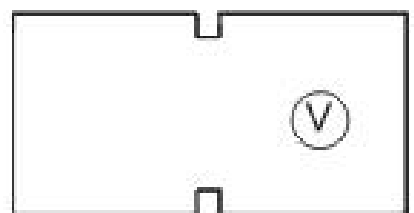
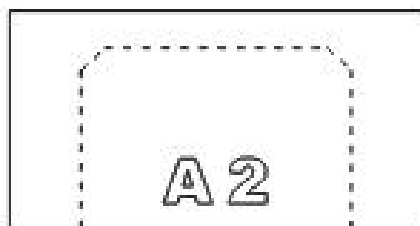
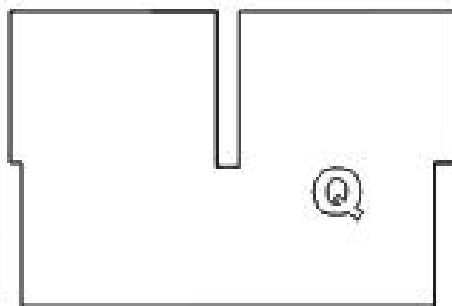
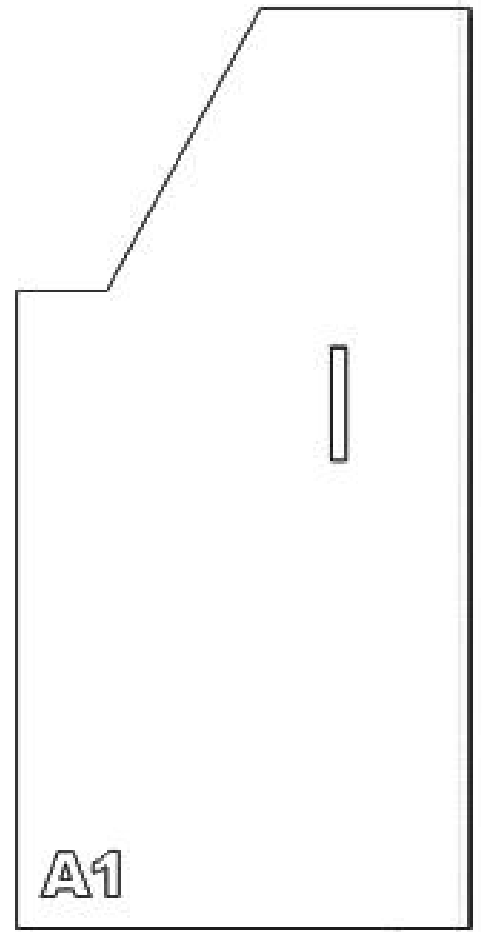
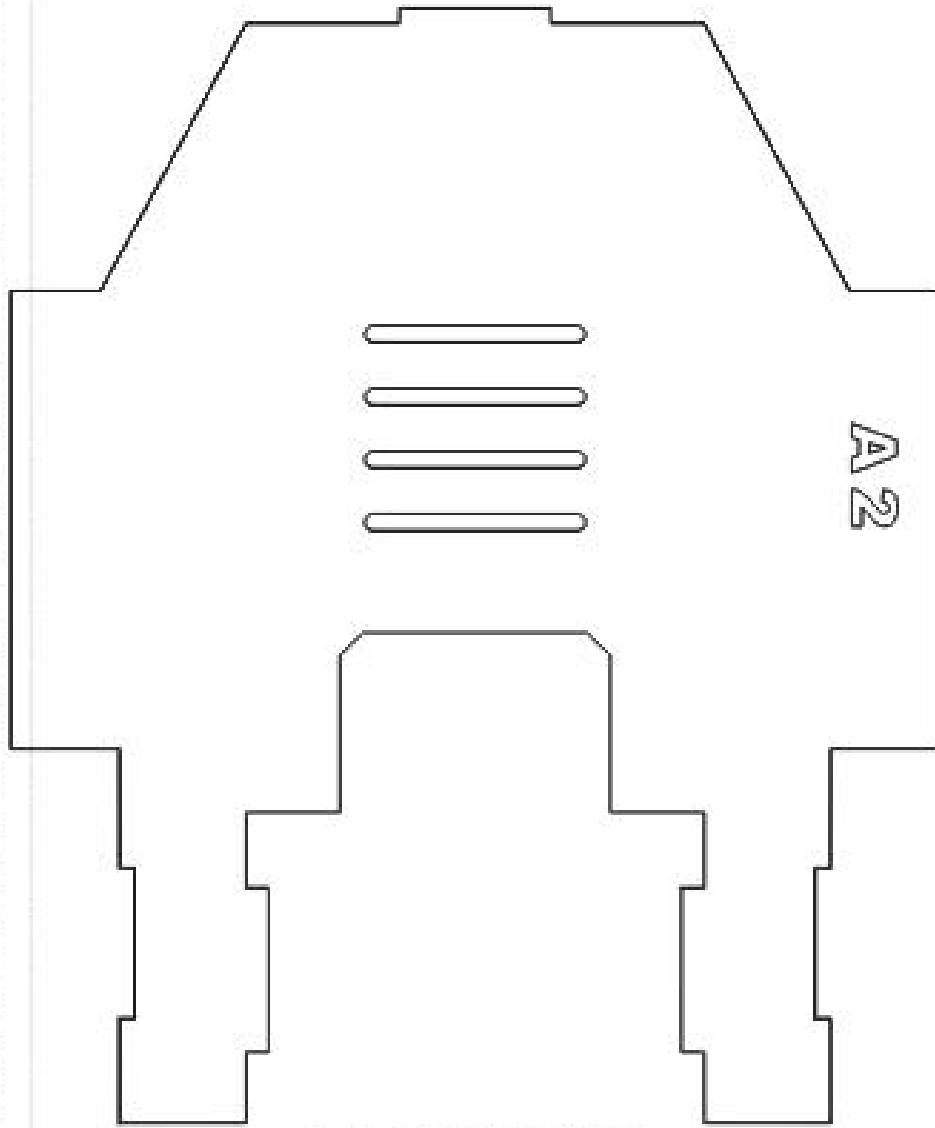



ILLUSTRATION QUALITY PAPER FOR FULL BLEED AND REGULAR COMIC BOOK PAGES. FINISHED ART PRINTS AT 87%





□ Plywood th. 2 mm.

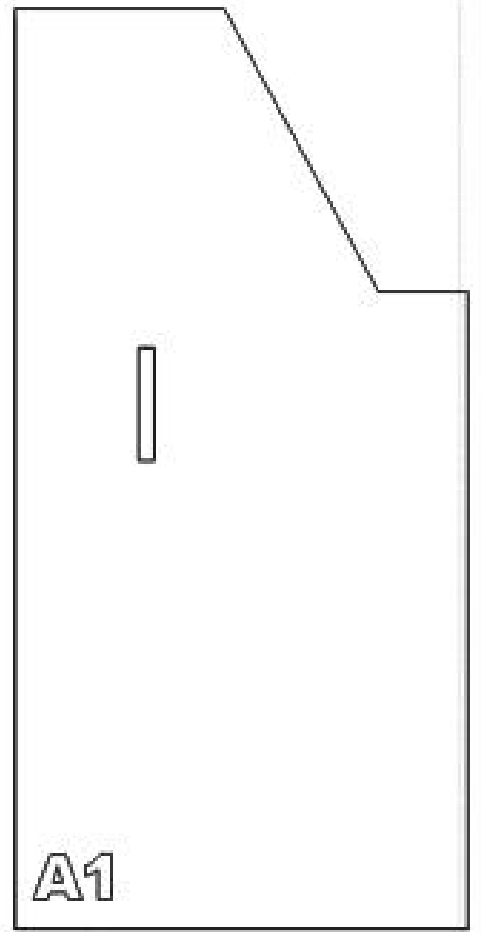
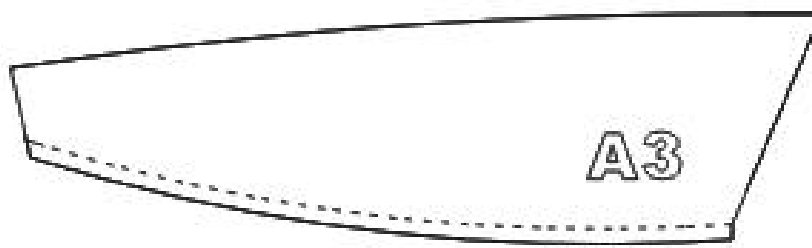
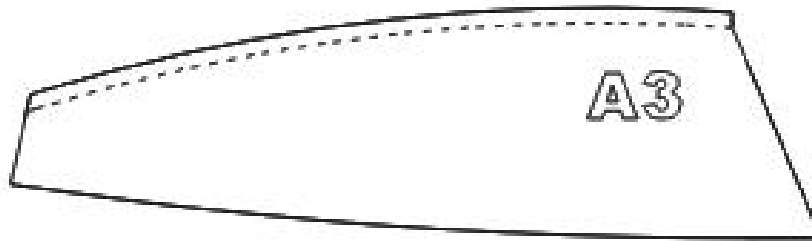

Scale factor - 80:1

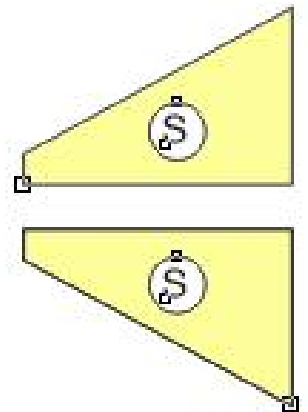
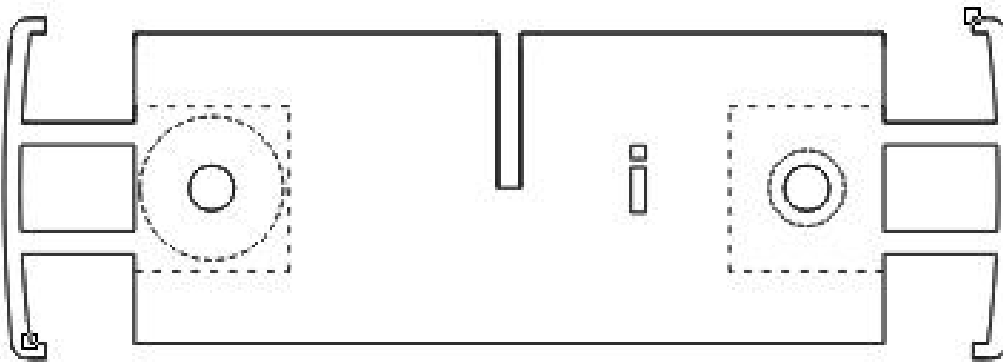
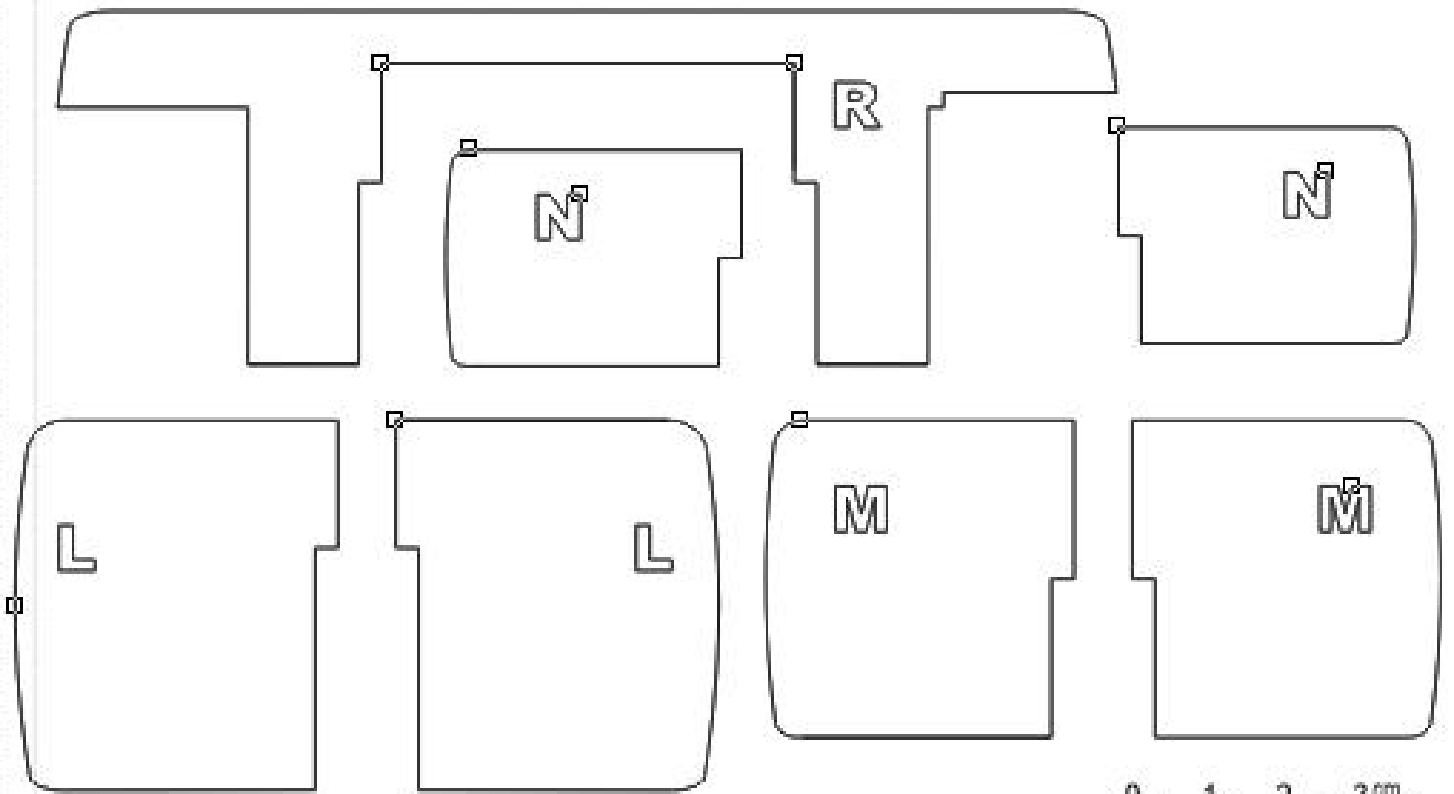



 Plywood th. 2 mm.
 Solid Wood

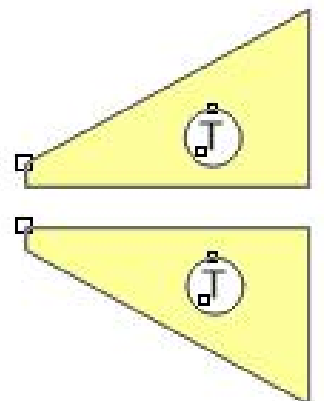
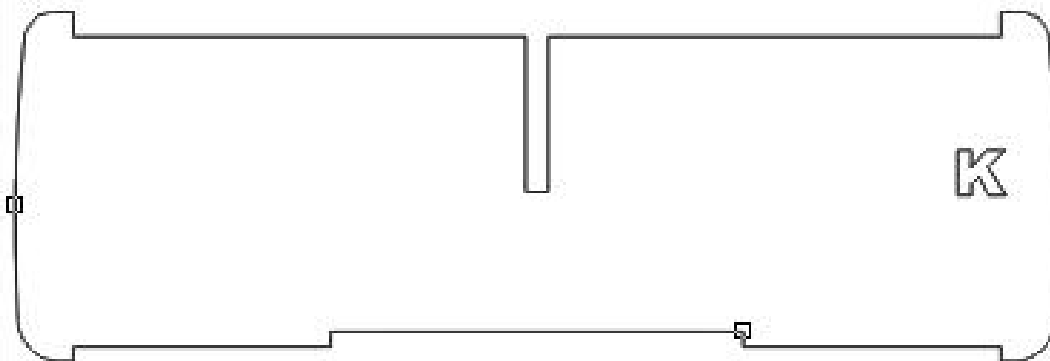
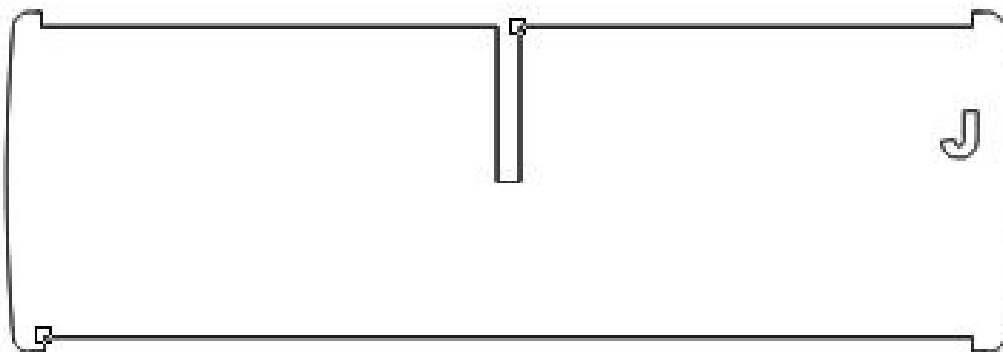

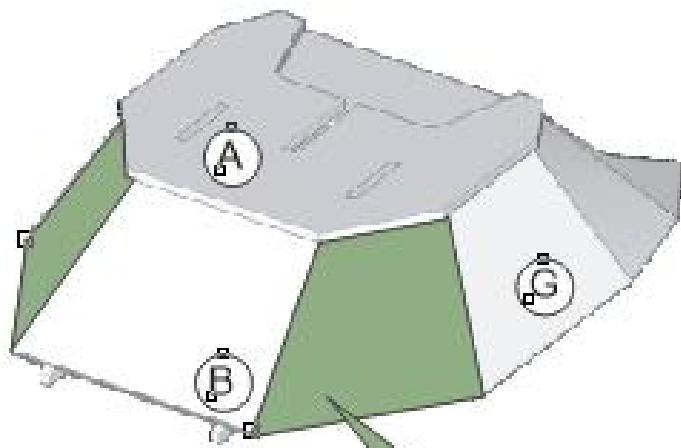

Front View

CUSTOM PARTS

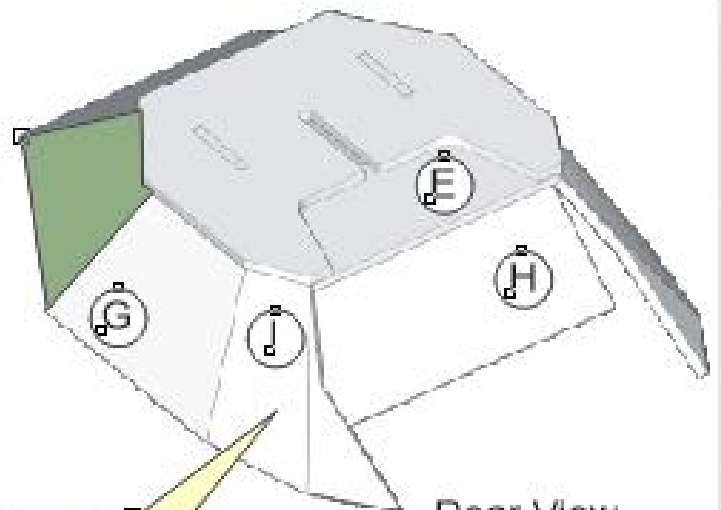

Rear View

This part must be customized

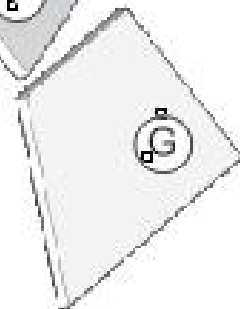
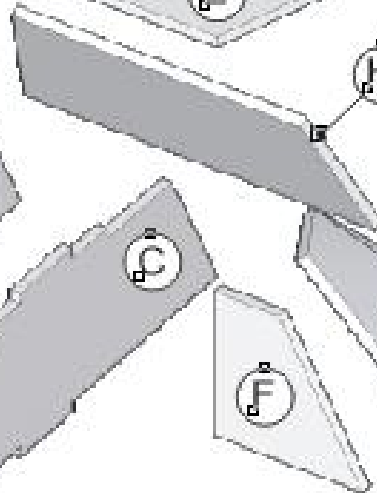
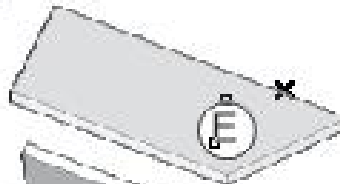
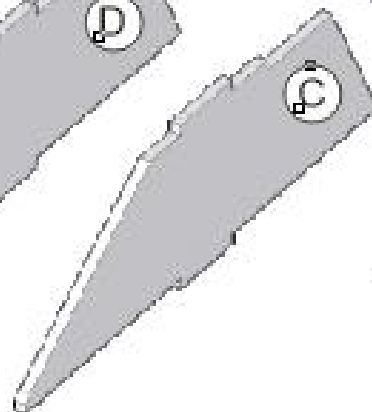
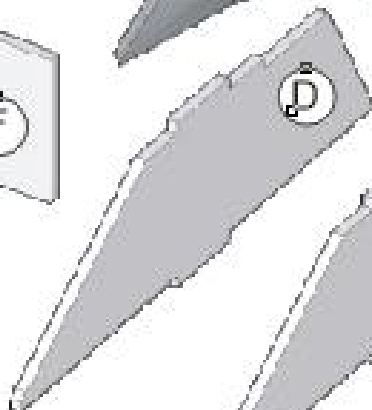
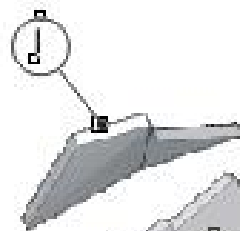
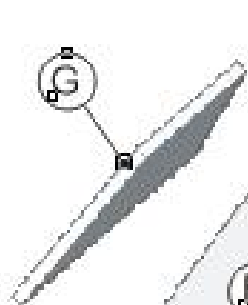
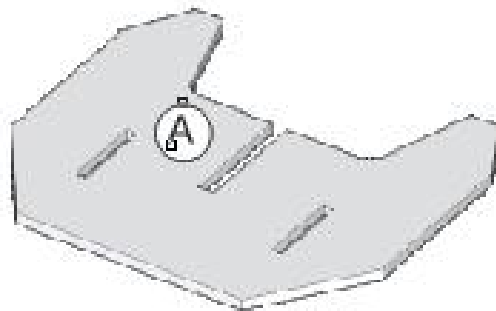

This part must be customized

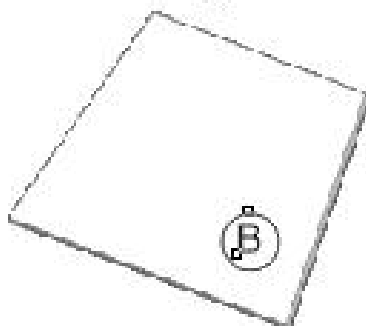

Exploded View

□ Plywood th. 2 mm.

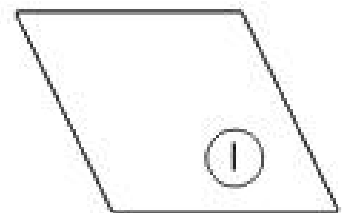
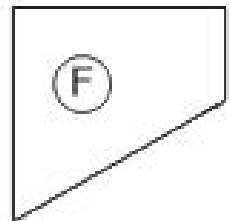
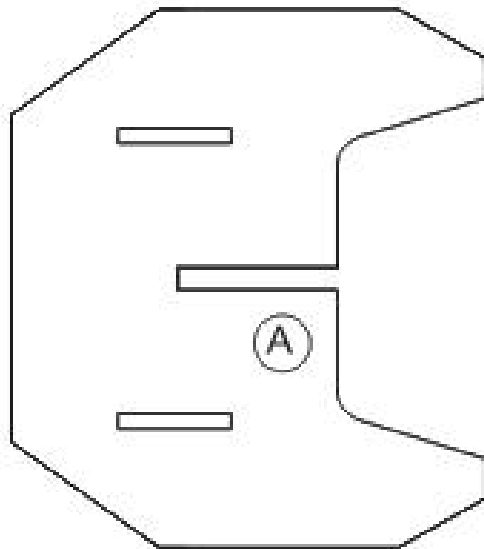
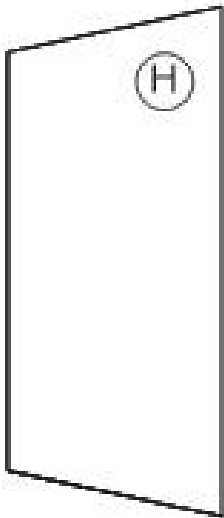
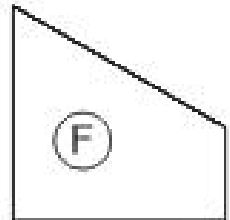
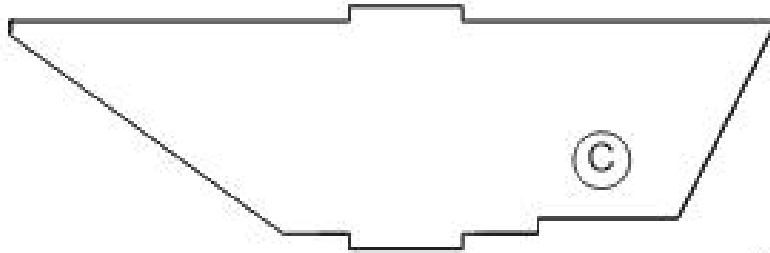
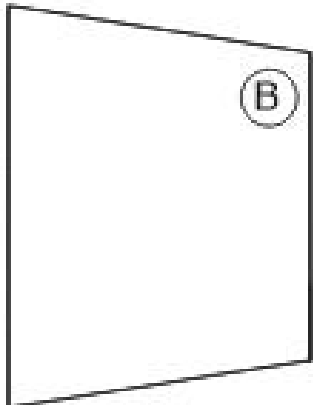
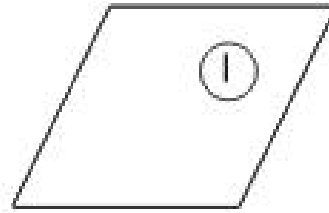
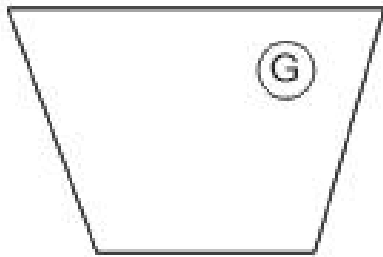
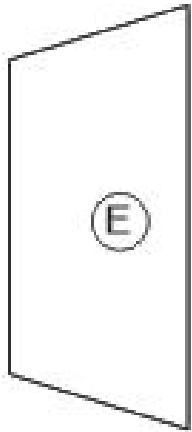

Plywood th. 2 mm.



Scale factor - 80:1

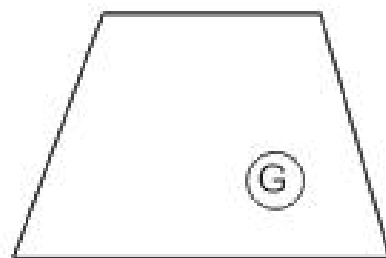
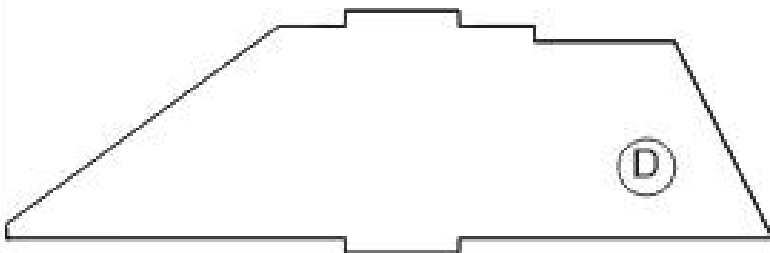

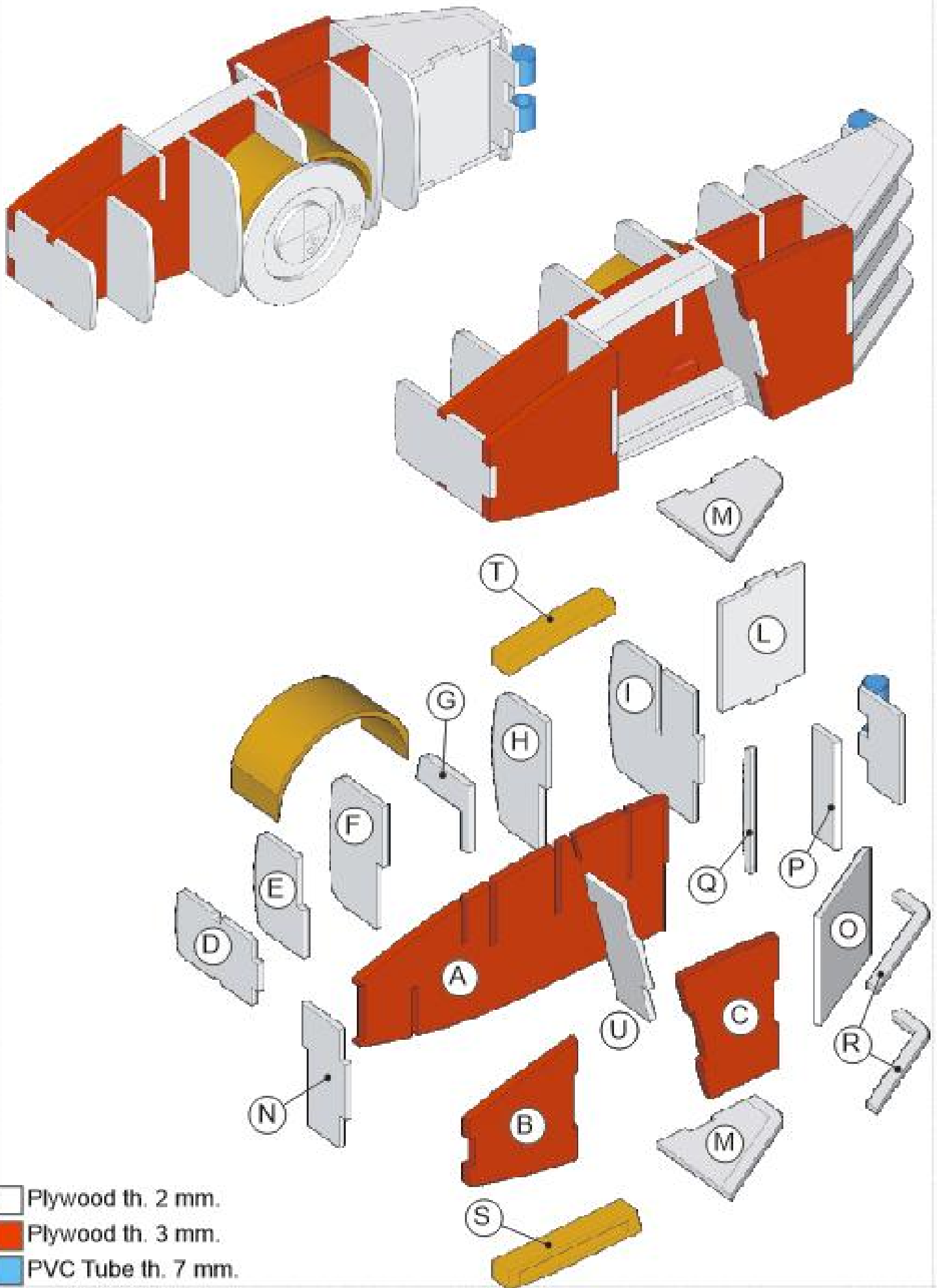



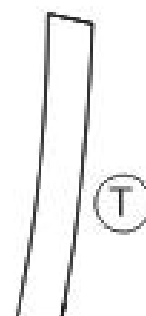
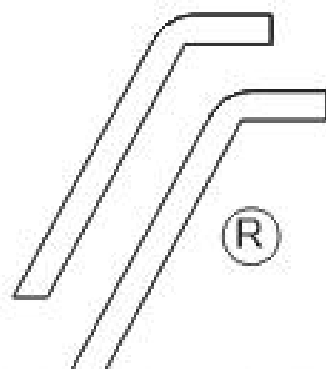
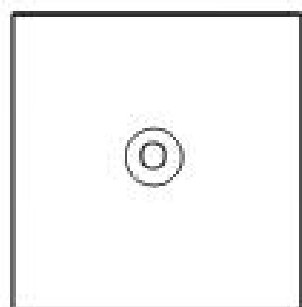
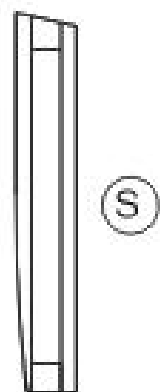
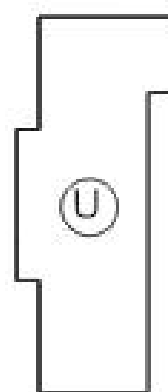
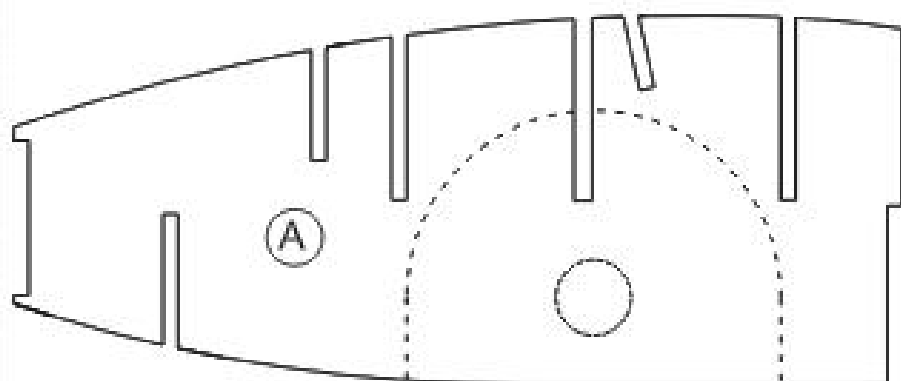
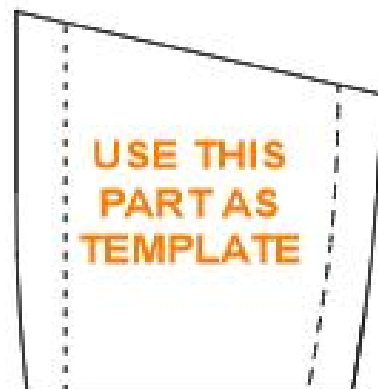
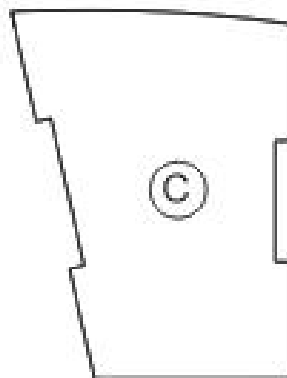
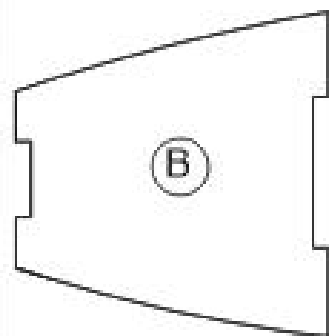
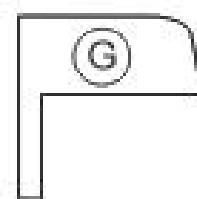
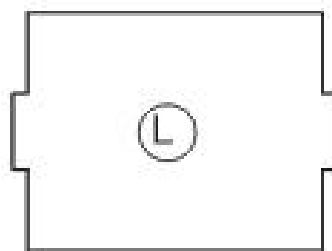
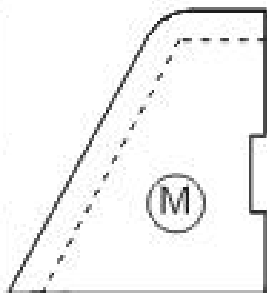
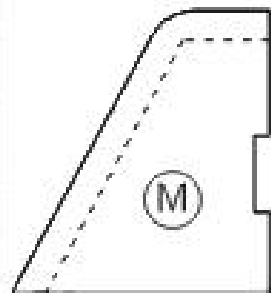
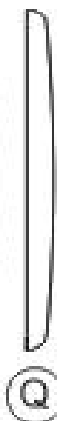
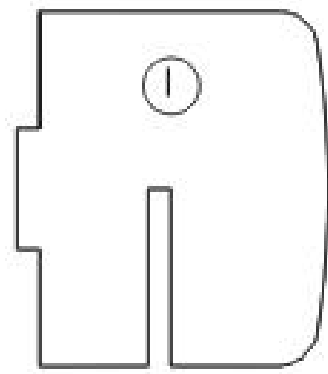
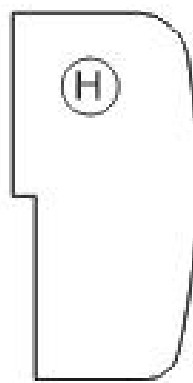
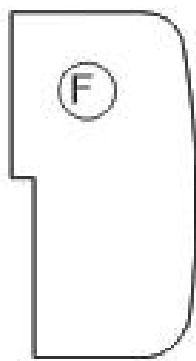
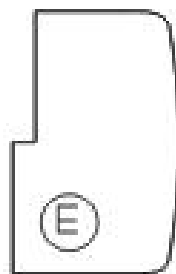
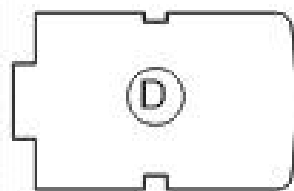

- Plywood th. 2 mm.
- Plywood th. 3 mm.
- PVC Tube th. 7 mm.

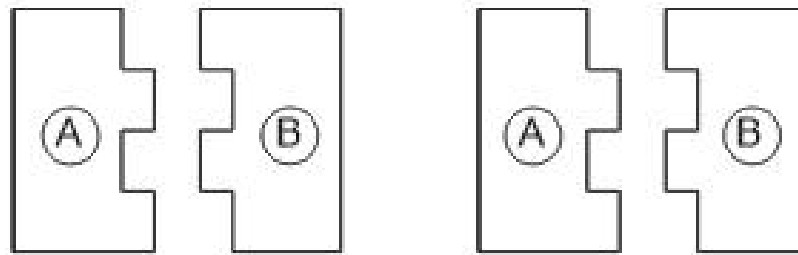
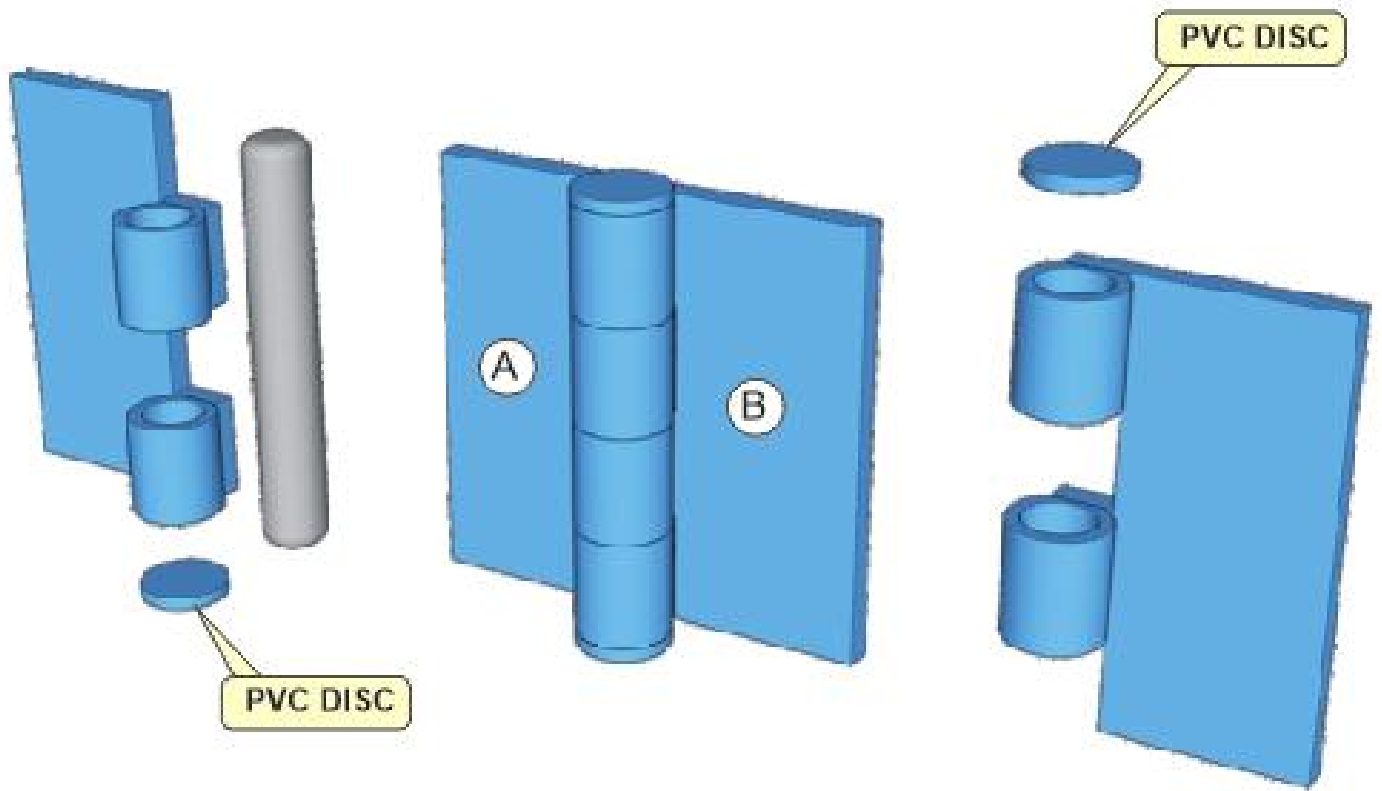

0 1 2 3 cm.
Scale 1:18 - 3511



-  PVC th. 1 mm.
-  Aluminum th. 5 mm.
-  PVC Tube th. 7 mm.



WARNING:
RIGHT WING SYMMETRICAL

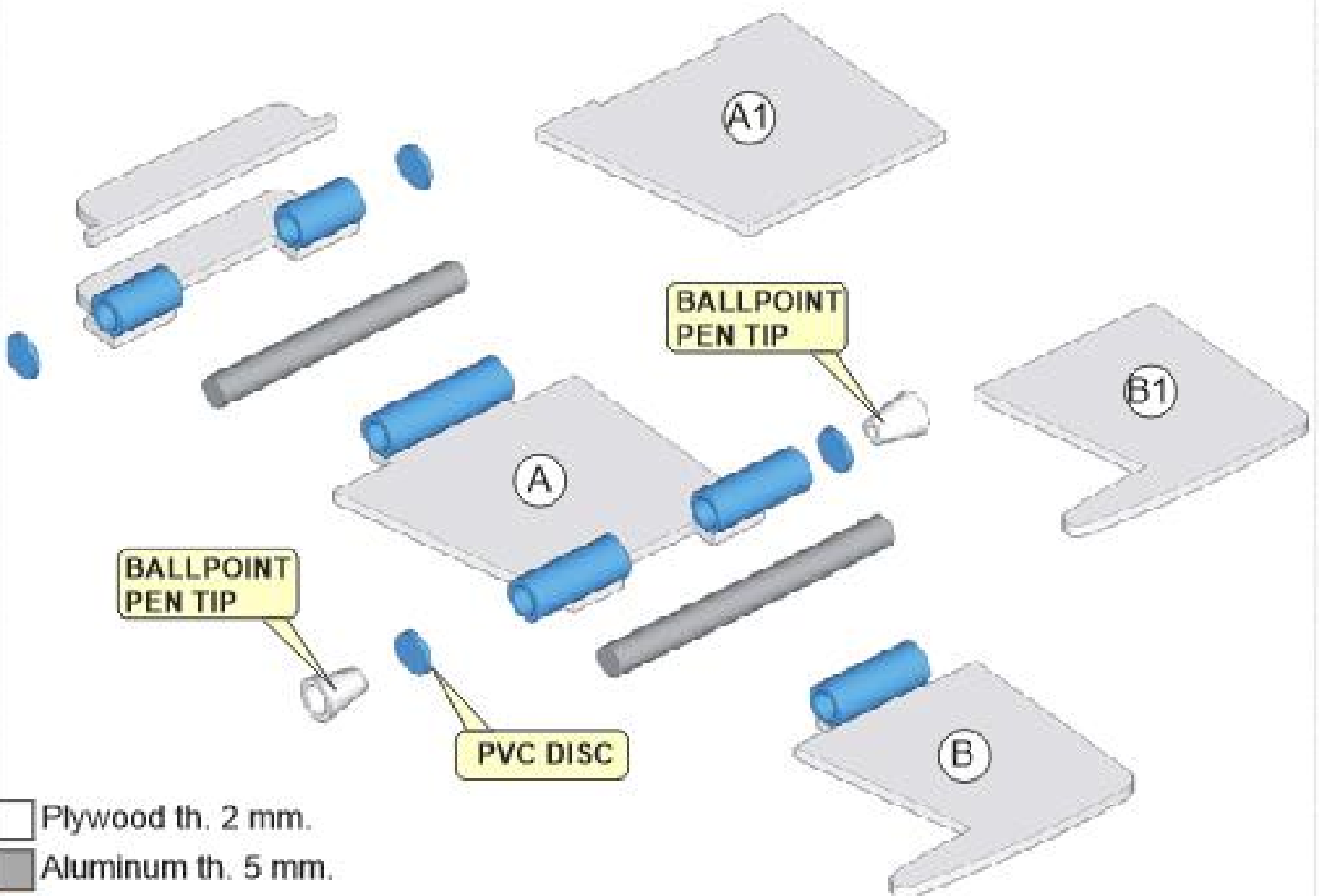
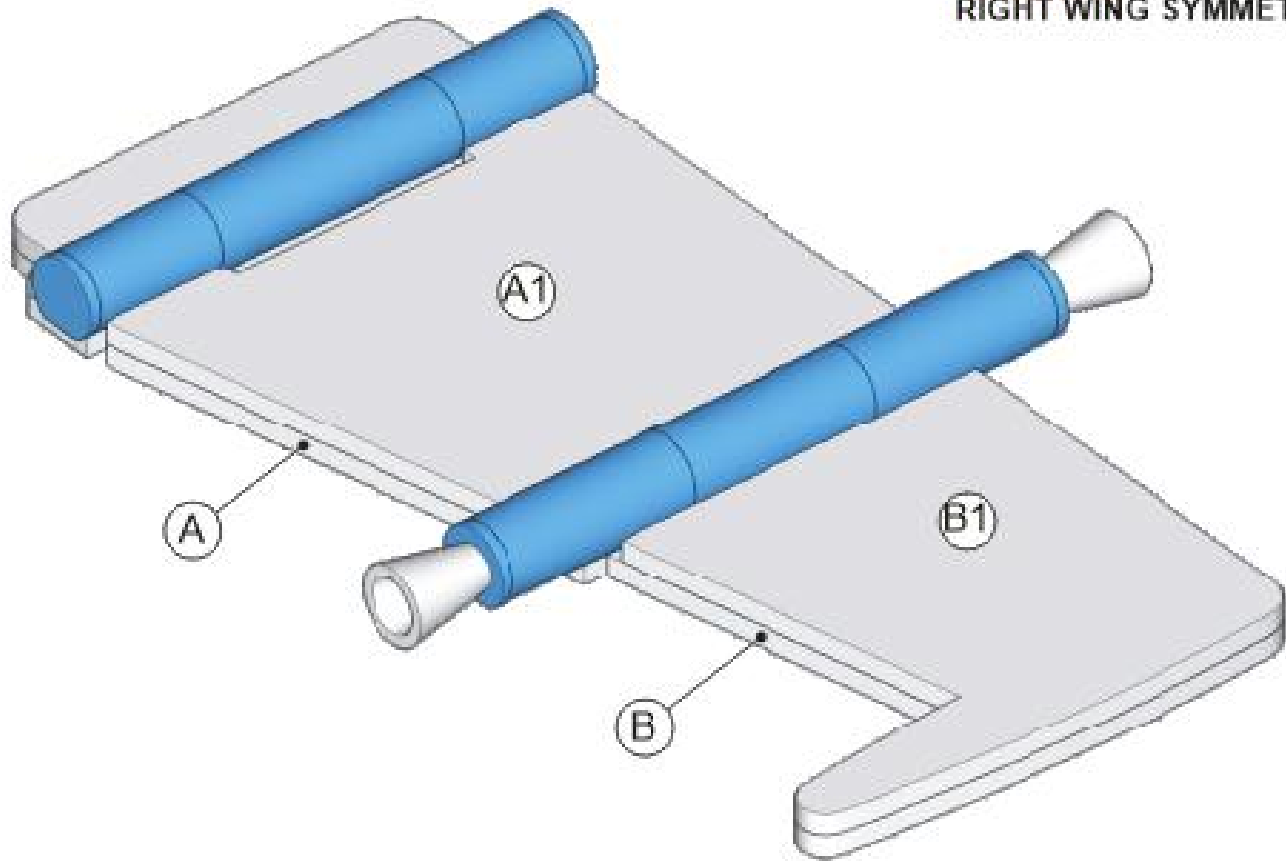

- Plywood th. 2 mm.
- Aluminum th. 5 mm.
- PVC Tube th. 7 mm.



ILLUSTRATION QUALITY PAPER FOR FULL BLEED AND REGULAR COMIC BOOK PAGES. FINISHED ART PRINTS AT 87%

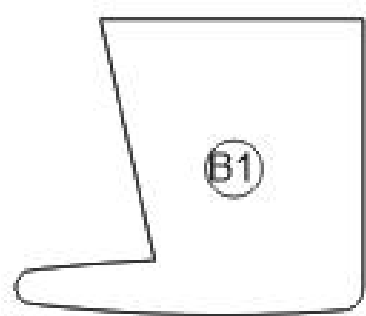
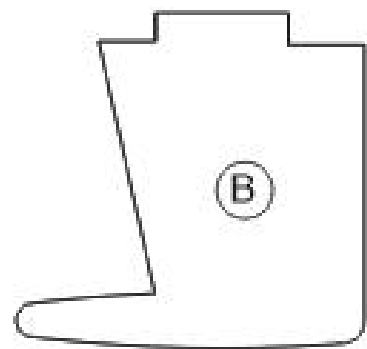
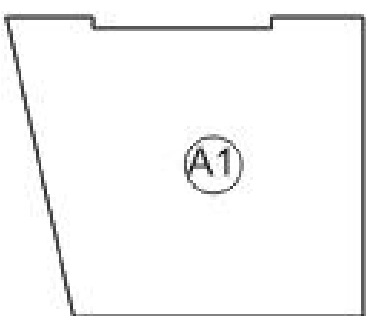
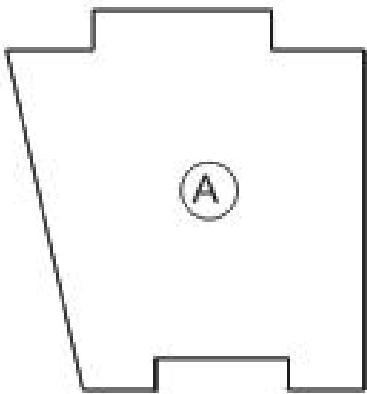
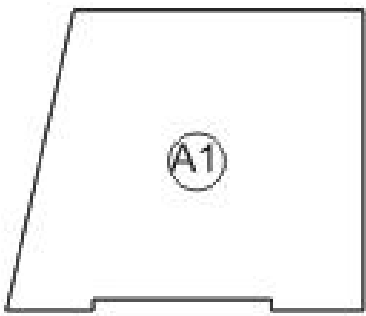
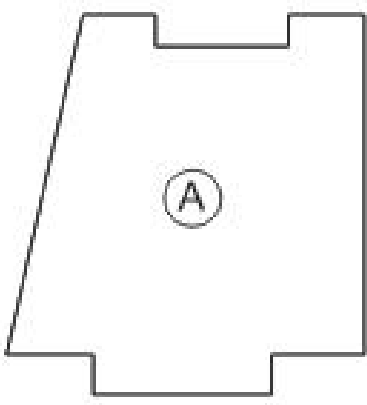
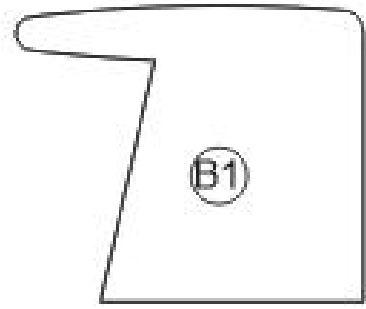
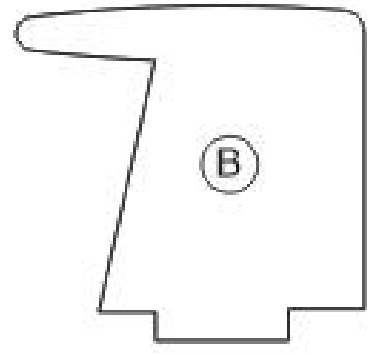

Scale: Model - 1:87 = 1

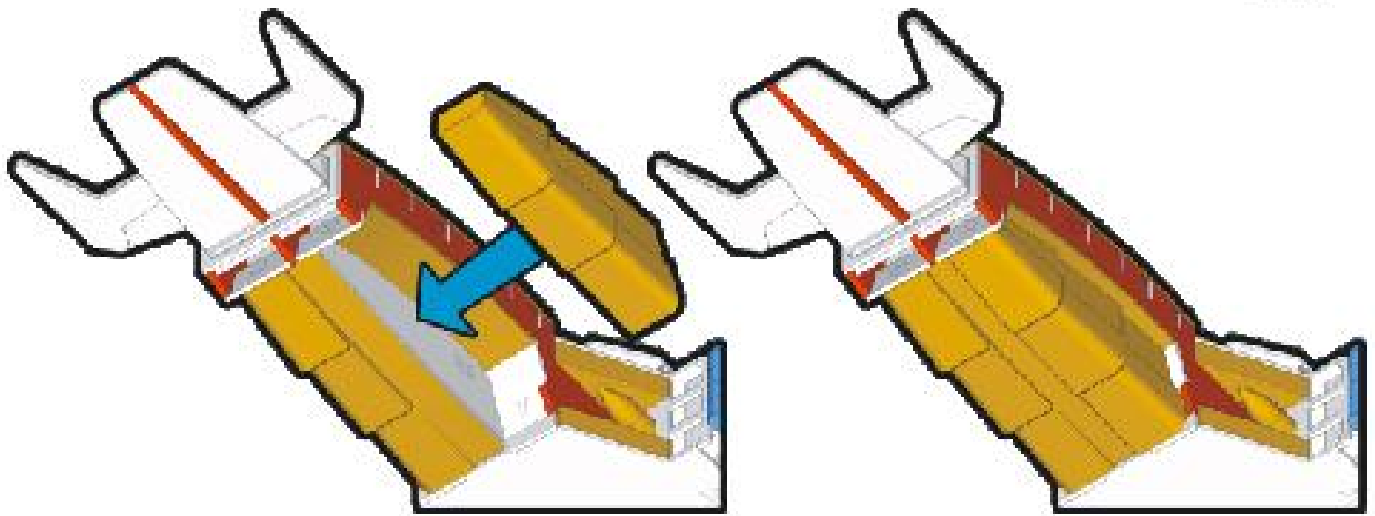
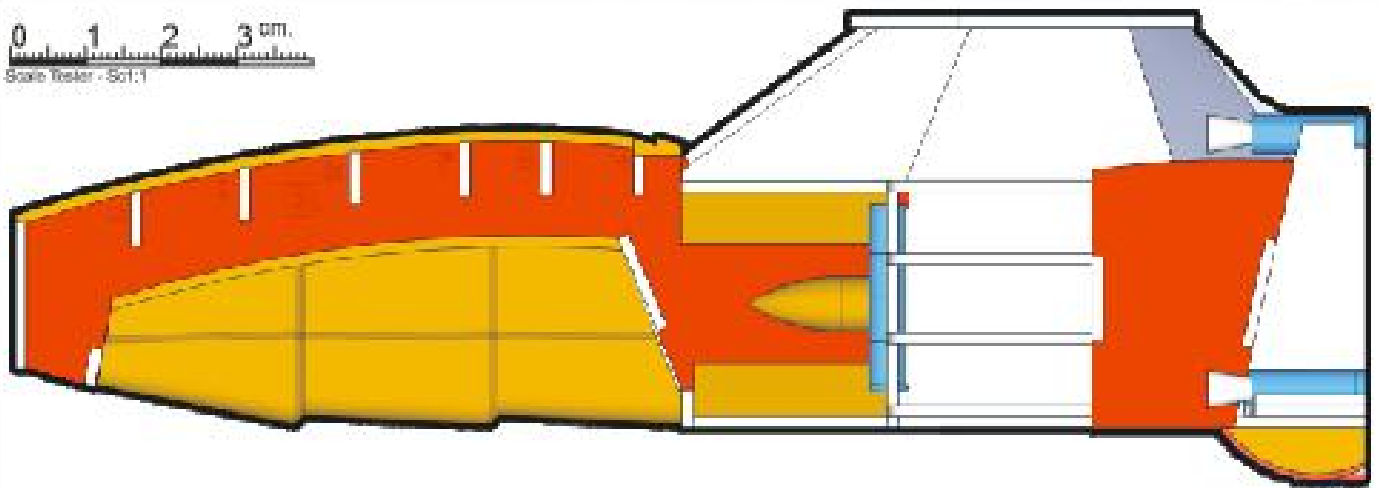

 Carved Solid Wood **USE THESE PARTS AS TEMPLATE**

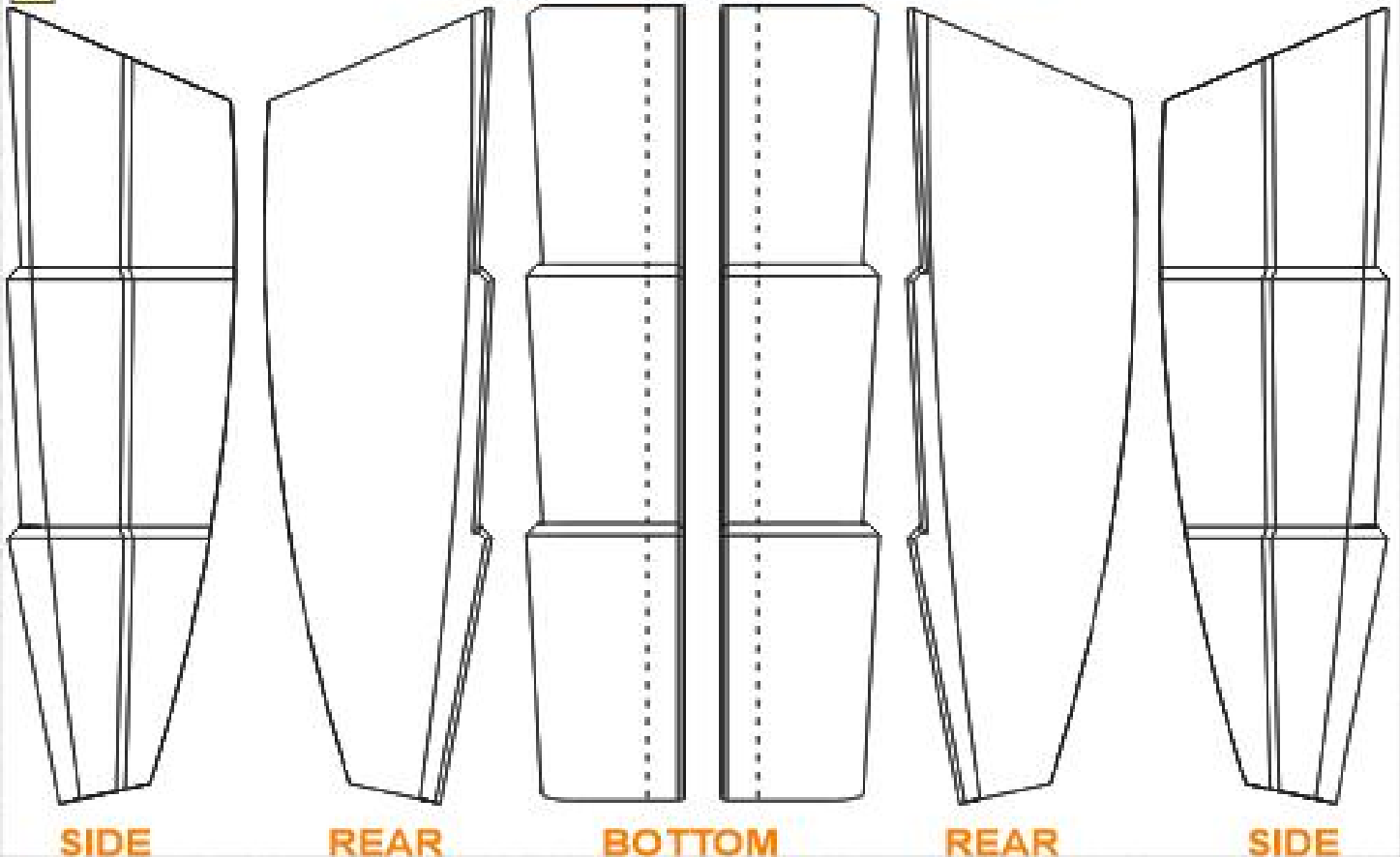

SIDE



REAR

BOTTOM

REAR

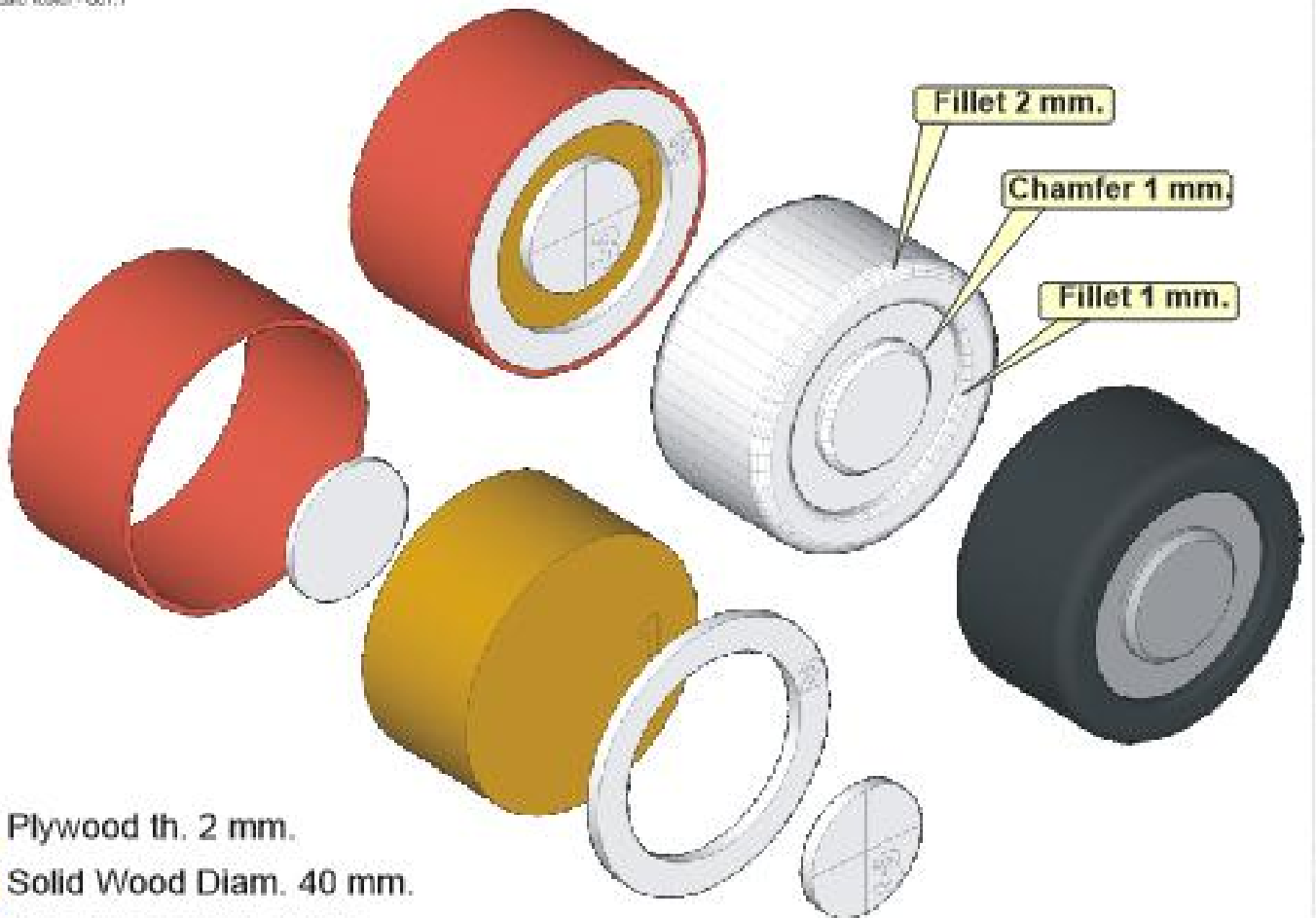
SIDE



-  Plywood th. 2 mm.
-  Solid Wood Diam. 40 mm.
-  Wood veneer th. 1 mm.

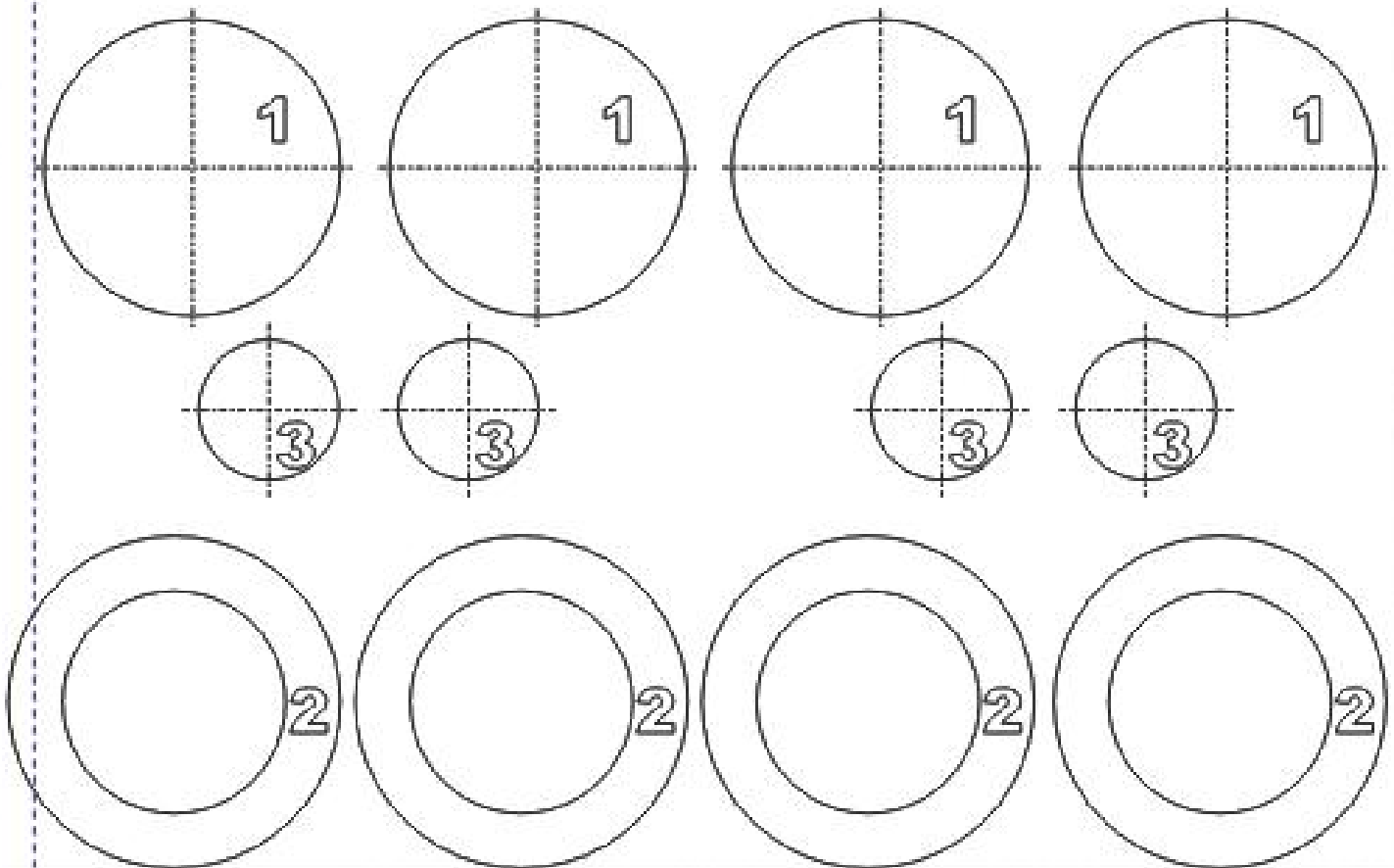
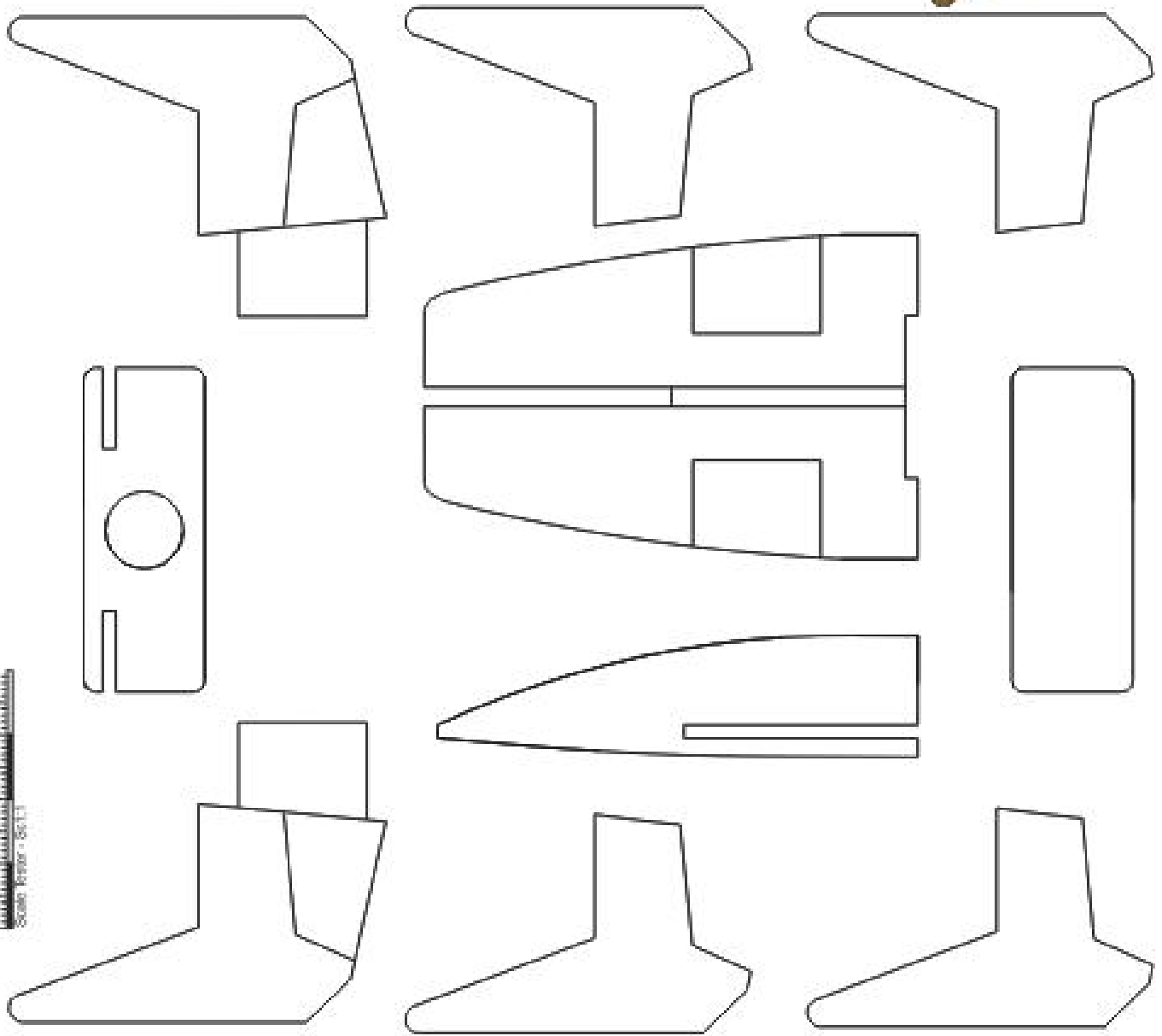
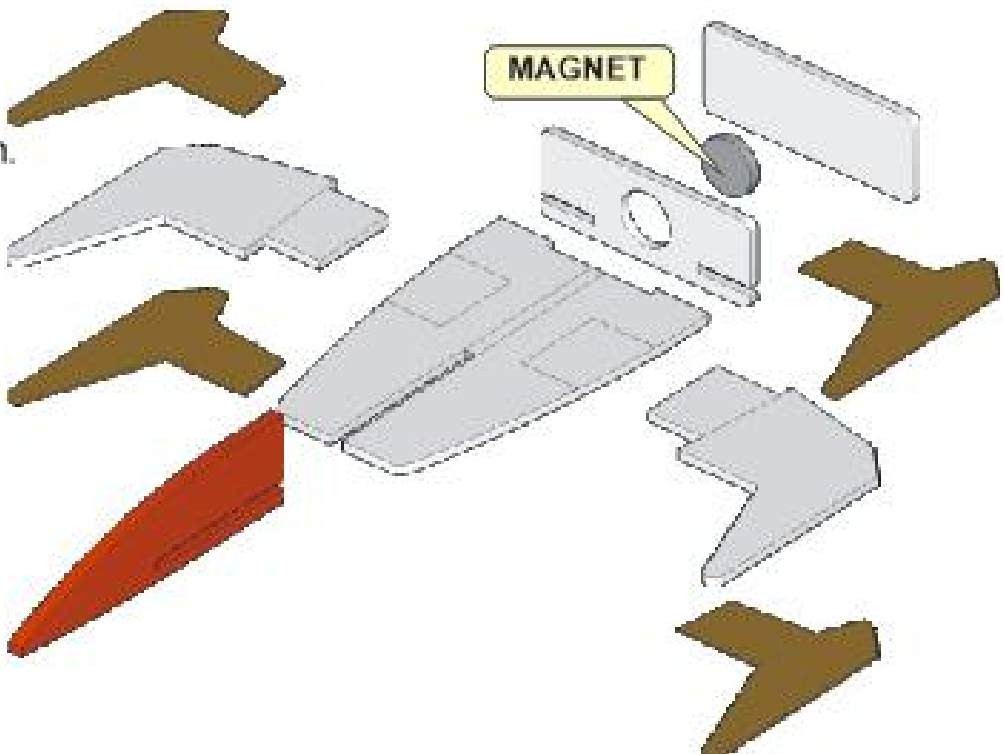



ILLUSTRATION QUALITY PAPER FOR FULL BLEED AND REGULAR COMIC BOOK PAGES. FINISHED ART PRINTS AT 67%

- Plywood th. 2 mm.
- Plywood th. 3 mm.
- Wood veneer th. 1 mm.



0 1 2 3 cm.
 0 1 2 3 cm.
 Scale 1mm - 8:1

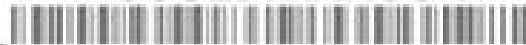
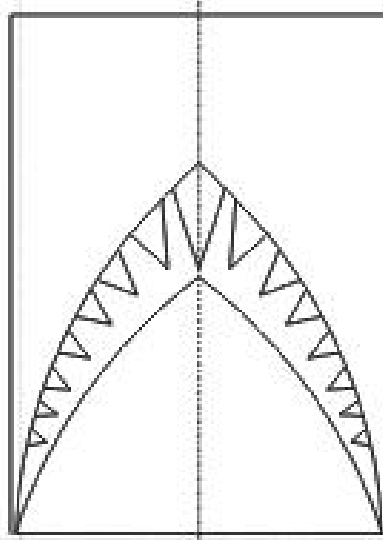
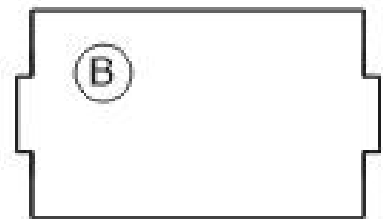
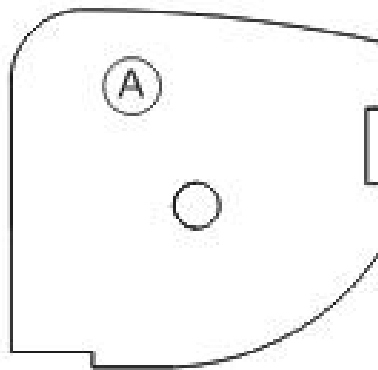
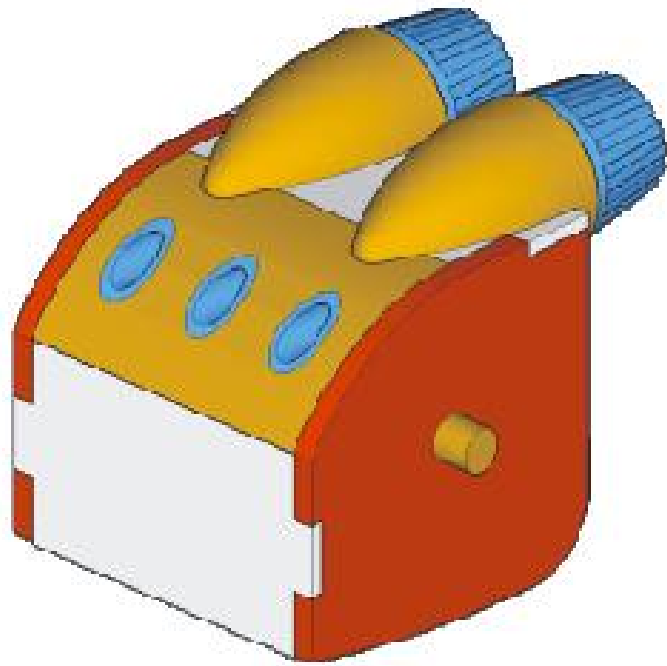







ILLUSTRATION QUALITY PAPER FOR FULL BLEED AND REGULAR COMIC BOOK PAGES. FINISHED ART PRINTS AT 87%

USE THESE PARTS AS DECAL TEMPLATES





-  Plywood th. 2 mm.
-  Plywood th. 3 mm.
-  Wood veneer th. 1 mm.
-  PVC Tube th. 7 mm.
-  Solid Wood

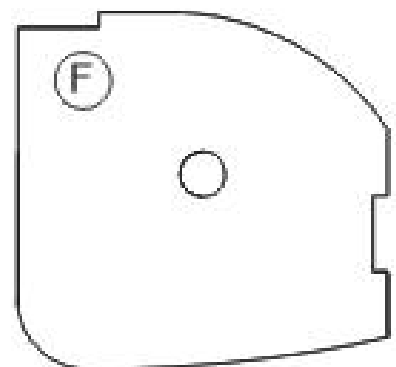
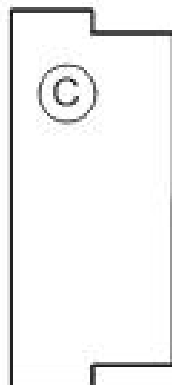

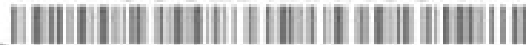
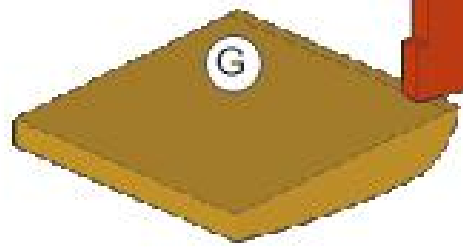
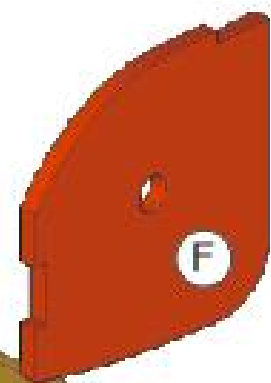
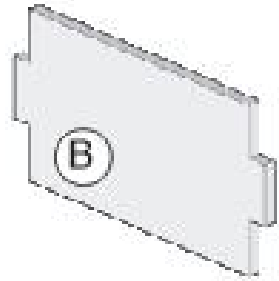
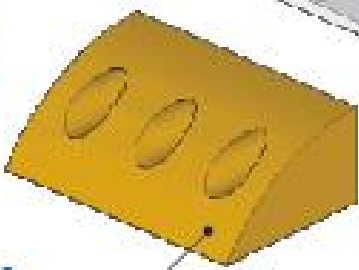
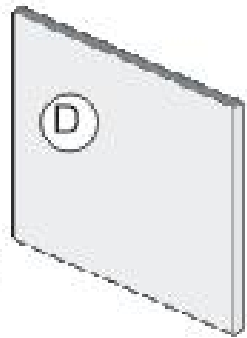
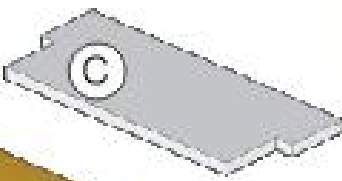
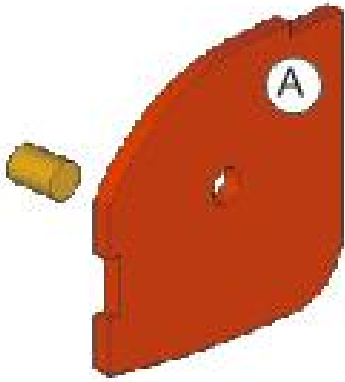
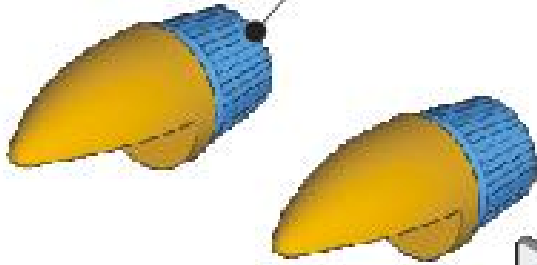
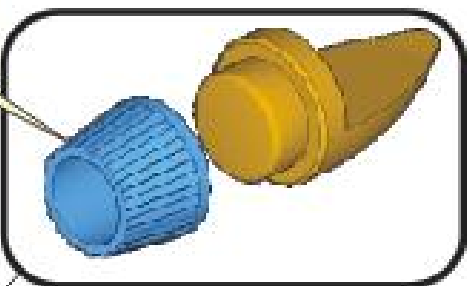

ILLUSTRATION QUALITY PAPER FOR FULL BLEED AND REGULAR COMIC BOOK PAGES. FINISHED ART PRINTS AT 87%

toothpaste cap



Exploded View



ILLUSTRATION QUALITY PAPER FOR FULL BLEED AND REGULAR COMIC BOOK PAGES. FINISHED ART PRINTS AT 67%

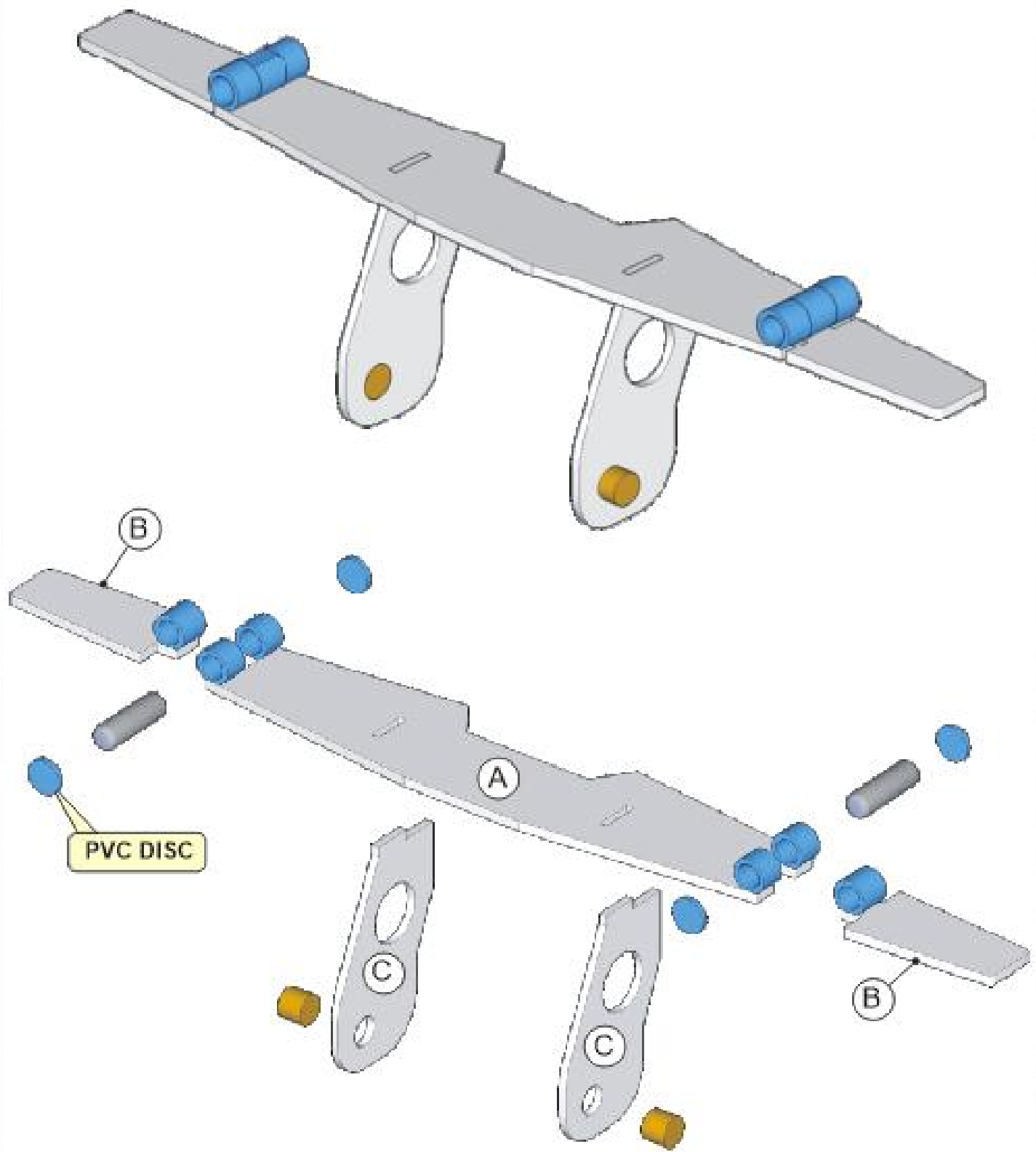



-  Plywood th. 2 mm.
-  Aluminum th. 5 mm.
-  PVC Tube th. 7 mm.



ILLUSTRATION QUALITY PAPER FOR FULL BLEED AND REGULAR COMIC BOOK PAGES. FINISHED ART PRINTS AT 87%



□ Plywood th. 2 mm.

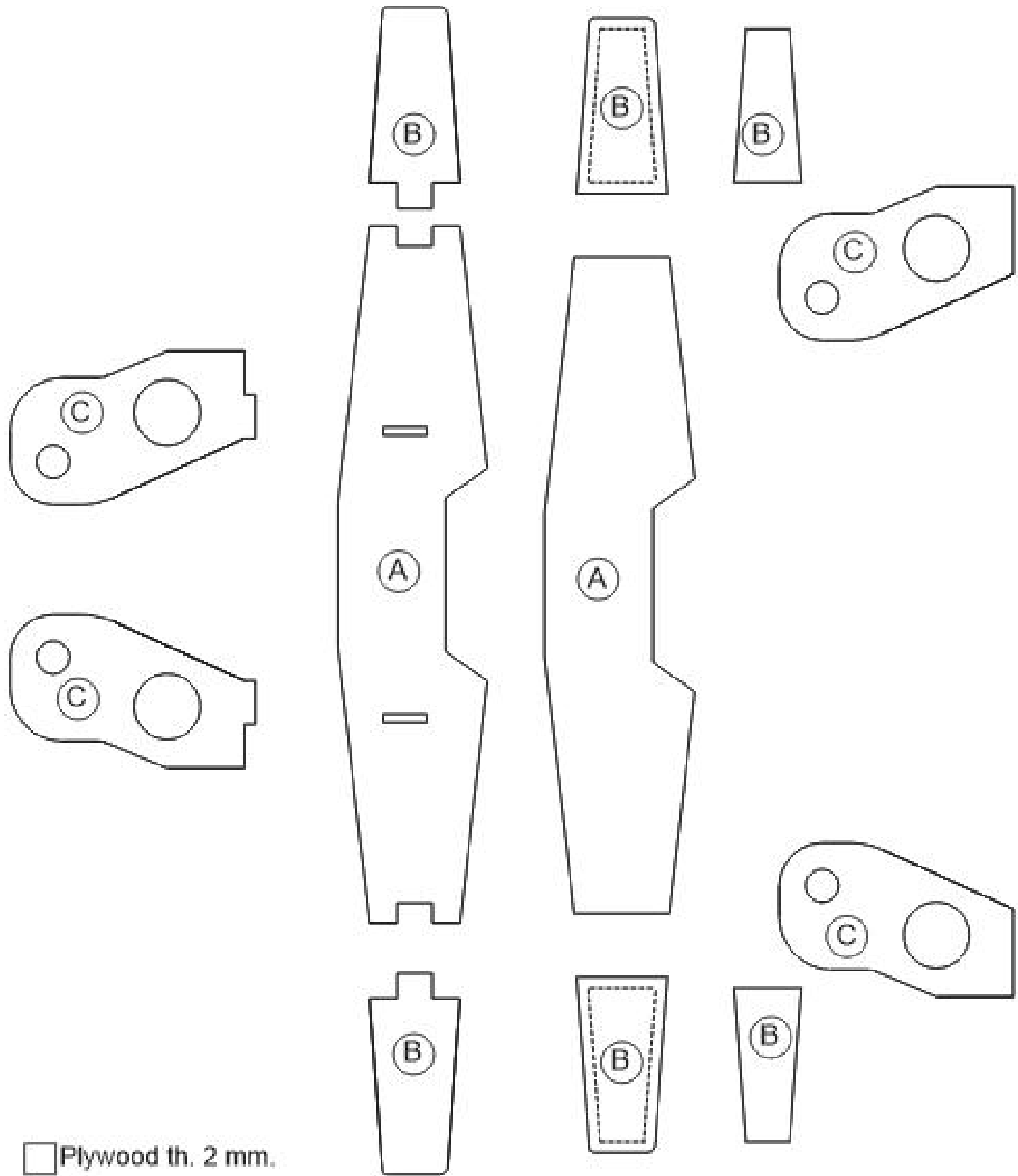

Scale Factor - 50:1

www.COSEDIMARCO.com



info@cosedimarco.com